

**Redegørelse i anledning  
af tre havarier  
med Dash8 Q400**

**Bilag til redegørelsens kap. 6**

**Hæfte 2**



## Bilag

Bilag 24	OPS-udv. krav til genaktivering af LD bevis 200907
Bilag 25	AOM 248
Bilag 26	AOM 249B
Bilag 27	OPS-udv krav til næsestel 270907
Bilag 27A	RD 84-32-064
Bilag 27B	SCR 101-07
Bilag 28	OPS-udv krav om NLG insp 270907
Bilag 29	Bombardier RD84-32-059 Issue 5 200907
Bilag 30	AOM 243
Bilag 30A	Bombardier RD84-32-059 Issue 4 140907
Bilag 30B	Goodrich SCR 086-07 rev C 140907
Bilag 31	AOM 245
Bilag 32	AOM 247
Bilag 32A	AOM 247, RD84-32-063 Issue 1
Bilag 32B	AOM 247, Goodrich SCR 091-07 rev NC
Bilag 33	AOM 250
Bilag 33A	Bombardier RD84-32-059 Issue 5 200907
Bilag 33B	Goodrich SCR 086-07 rev D 200907
Bilag 34	SAS indberetning vedr. havari med LN-RDI SK2867 27.10.07
Bilag 34A	OPS-udvalget meddeler flyveforbud 27.10.07
Bilag 35	HCLJ redegørelse af 29.10.07 vedr. LN- RDI
Bilag 36	HCLJ redegørelse af 30.10.07 vedr. LN- RDI
Bilag 37	HCLJ redegørelse af 03.11.07 vedr. LN- RDI
Bilag 38	STK release doc. for LN-RDI
Bilag 39	AOM 263





## **Bilag 24**





2007-09-20

STK 2007-0280-3

De skandinaviske luftfartsmyndighedernes  
samarbetsorgan for flygsikkerhedsfrågor

**STK** DET SKANDINAVISKE TILSYNSKONTOR  
DENMARK NORWAY SWEDEN

Accountable manager  
John Dueholm  
Scandinavian Airlines System  
Denmark-Norway-Sweden  
STODA

Kopia:  
STOOM  
STOOG  
STOOF  
STODO-X  
STODG

## Genaktivering af luftdygtighedsbeviser på luftfartøjer af typen Bombardier DHC8-Q400.

Der henvisning til OPS-udvalgets brev af 12. september 2007, som midlertidigt inddrager luftdygtighedsbeviset på en række angivne luftfartøjsindivider af ovennævnte type opereret af SAS.

I brev af 13. september 2007 har OPS-udvalgt meddelt tilladelse til færgeflyvning af de pågældende luftfartøjer.

I fortsættelse heraf skal OPS-udvalget meddele, at luftdygtighedsbeviserne vil blive genaktiveret pr. individ forudsat at følgende betingelser er dokumenteret opfyldt:

1. EASA EAD No:2007-0252-E dateret 13. september 2007, eller senere godkendte udgave, er udført og eventuelle fejl og anmærkninger er udbedret. Arbejdet skal være udført i overensstemmelse med fabrikantens og myndighedernes senest udarbejdede retningslinier herom, idet der henvises til TC AD note Nr. CF-2007-20 af 12. september 2007, eller senere godkendte udgave, med tilhørende forskrifter.
2. Main Landing Gear Retract Actuator (p/n 46550-7/-9) er udskiftet med en fabriksny actuator, eller en actuator, hvor der er installeret fabriksnyt Piston (p/n 46570-1/-3) i overensstemmelse med fabrikantens forskrifter. Rework i h.t. Goodrich tegning S2116 eller S2117 accepteres således ikke.
3. På alle actuators skal der være installeret en ny Rod End (p/n P3A2750).
4. Ovennævnte punkt 1, 2 og 3 er gældende for højre såvel som venstre sides landingsstelinstallation.
5. Der skal foretages fuld funktionsprøve på udfældning og indfældning af landingsstellene i henhold til fabrikantens forskrifter, for normal såvel som alternativ udfældningsmetode. Dette skal også foretages uanset om Goodrich Setting Tool CG-56806 anvendes til evt. justering af Rod End (p/n P3A2750).

STK - Det Skandinaviske Tilsynskontor  
Luftfartsstyrelsen  
SE-601 73 NORRKÖPING  
Visiting address: Bergkällavägen 32  
SOLLENTUNA, Sweden

Phone  
+ 46 (0)11 41 52100

E-mail: stk@luftfartsstyrelsen.se  
SITA CODE BMAZVSK

Facsimile  
+ 46 (0)11 41 52490

6. Det skal dokumenteres overfor STK, ved særskilt liste eller notat, at luftfartøjet opfylder gældende krav til relevante AD notes for landingsstelinstallationen.
7. Der må ikke forefindes henstående anmærkninger eller henstående vedligeholdelsesopgaver på landingsstelinstallationen.


Ved fremsendelse til STK af at fornøden dokumentation for opfyldelse af ovennævnte vilkår, vil STK herefter meddele fornyet aktivering af luftdygtighedsbeviset for det pågældende luftfartøj .

Ovennævnte er gældende for følgende luftfartøjsindivider:

LN-RDA, LN-RDB, LN-RDC, LN-RDD, LN-RDE, LN-RDF, LN-RDG, LN-RDH, LN-RDI, LN-RDJ, LN-RDL, LN-RDM, LN-RDO, LN-RDP, LN-RDQ, LN-RDR, LN-RDT, OY-KCD, OY-KCE, OY-KCF og OY-KCG.

I det omfang de 2 havarerede luftfartøjer LN-RDK og LN-RDS igen sættes i drift, er kravene ligeledes gældende for disse luftfartøjer.

**På vegne af luftfartsmyndighederne i Danmark, Norge och Sverige.**

*for* 

Kurt Lykstoft Larsen  
Ordförande OPS-utvalget

## **Bilag 25**



## Bombardier Q400

### All Operator Message No. 248

---

ATTN: Director/Manager of: Maintenance  
Engineering  
Quality Control  
Flight Operations  
Procurement/Spares

DATE: 21 September 2007

ATA: 0000 MODEL: Q400

SUBJECT: In-Service Incident – Aircraft Landed with Nose Landing Gear Retracted

The following message is being sent to all Bombardier Aerospace Regional Aircraft Q400 Operators and Bombardier Aerospace Regional Aircraft Field Service Representatives.

This message contains information requiring attention and/or action. Please ensure timely and appropriate distribution within maintenance and flight operations departments.

---

#### DISCUSSION:

This All Operator Message is being issued to advise Operators of an incident that has occurred on a Dash 8 Q400 aircraft. Bombardier Aerospace received preliminary reports of a Q400 having landed with the Nose Landing Gear Retracted. There were no reported injuries to the passengers or crew.

This incident is unrelated to recent Q400 Main Landing Gear malfunctions.

Bombardier Aerospace, and Goodrich have dispatched representatives to the scene. Operators will be informed of any recommended actions.

Please direct responses and inquiries to the Technical Help Desk in Toronto at telephone (416) 375-4000 or facsimile (416) 375-4539 or e-mail: [thd.gseries@aero.bombardier.com](mailto:thd.gseries@aero.bombardier.com)

Alisa Turk, Manager, Technical Help Desk, and Martin Elliott, Director, In-Service Engineering Systems & Technical Support, Bombardier Aerospace Regional Aircraft.





## **Bilag 26**



## Bombardier Q400

### All Operator Message No. 249B

---

ATTN: Director/Manager of: Maintenance  
Engineering  
Quality Control  
Flight Operations  
Procurement/Spares

DATE: 24 September 2007

ATA: 3220 MODEL: Q400

SUBJECT: Inspection Recommendations Following In-Service Incident – Aircraft Landed with Nose Landing Gear Retracted

REFERENCE: AOM 248 - In-Service Incident – Aircraft Landed with Nose Landing Gear Retracted  
SCR 101-07 Rev B– Inspection of Nose Landing Gear (NLG) forward door spring  
RD 8/4-32-064- Rework instructions for trimming the lower edge of the Nose Landing Gear Door Mechanism Debris guard, P/N 83220012, to remove / prevent chafe damage with the spring assembly

The following message is being sent to all Bombardier Aerospace Regional Aircraft Q400 Operators and Bombardier Aerospace Regional Aircraft Field Service Representatives.

This message contains information requiring attention and/or action. Please ensure timely and appropriate distribution within maintenance and flight operations departments.

---

#### DISCUSSION:

This AOM is being re-issued with Revision B of the SCR 101-07, which clarifies the requirements for Liquid Penetrant Inspection and to notify Operators of the release of RD 8/4-32-064 for modification of the debris shield.

All Operator Message 248 was previously issued to advise Operators of an incident in which the Nose Landing Gear failed to extend. A Bombardier / Goodrich team has been dispatched to the site to support the ongoing investigation. Based on the preliminary investigation results, Operators are recommended to inspect the NLG forward door spring as described in Service Concession Request (SCR) 101-07 Rev B.

Operators are requested to provide results of the SCR inspection to the Technical Help Desk at facsimile (416) 375-4539 or e-mail: [thd.qseries@aero.bombardier.com](mailto:thd.qseries@aero.bombardier.com), using the attached spreadsheet template.

Operators will be advised as the investigation progresses and further information becomes available.

RD 8/4-32-064 is being issued to allow Operators to trim the debris shield to eliminate the possibility of chaffing between the debris shield and the NLG forward door spring. It is recommended that Operators incorporate the RD as soon as practical.

Please direct responses and inquiries the Technical Help Desk in Toronto at telephone (416) 375-4000 or facsimile (416) 375-4539 or e-mail: [thd.qseries@aero.bombardier.com](mailto:thd.qseries@aero.bombardier.com)

Alisa Turk, Manager, Technical Help Desk, and Martin Elliott, Director, In-Service Engineering Systems & Technical Support, Bombardier Aerospace Regional Aircraft.

## **Bilag 27**





2007-09-27

STK 2007-0280-4

De skandinaviska luftfartsmyndigheternas  
samarbetsorgan för flygsäkerhetsfrågor

**STK** DET SKANDINAVISKE TILSYNSKONTOR  
DENMARK NORWAY SWEDEN

Accountable manager  
John Dueholm  
Scandinavian Airlines System  
Denmark-Norway-Sweden  
STODA

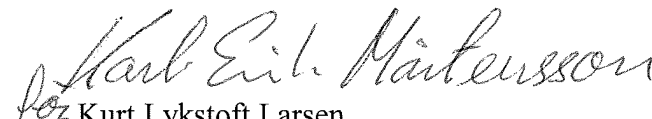
Kopia:  
STOOM  
STOOG  
STOOF  
STODO-X  
STODG

### **Krævet inspektion af næse landingsstellet på luftfartøjer af typen Bombardier DHC8-Q400.**

I fortsættelse af OPS-udvalgets brev af 20. september 2007 vedrørende betingelserne for genaktivering af luftdygtighedsbeviserne for SAS opererede luftfartøjer af ovennævnte type, kræves inspektion af næsestellet som anført i Bombardier AOM249B eller senere godkendte udgave udført før videre flyvning.

Kravet skal ses i lyset af havariet med et tysk registreret luftfartøj af samme type den 21. september 2007 i München, og har således ingen relation til havarierne i Aalborg og Vilnius, hvor højre hovedunderstel kollapsede.

På vegne af luftfartsmyndighederne i Danmark, Norge och Sverige.

  
for Kurt Lykstoft Larsen  
Ordförande OPS-utvalget

STK - Det Skandinaviske Tilsynskontor  
Luftfartsstyrelsen  
SE-601 73 NORRKÖPING  
Visiting address: Bergkällavägen 32  
SOLLENTUNA, Sweden

Phone  
+ 46 (0)11 41 52100

E-mail: [stk@luftfartsstyrelsen.se](mailto:stk@luftfartsstyrelsen.se)  
SITA CODE BMAZVSK

Facsimile  
+ 46 (0)11 41 52490





## **Bilag 27A**



# BOMBARDIER

## REPAIR DRAWING (RD)

1 TITLE <b>Rework instructions for trimming the lower edge of the Nose Landing Gear Door Mechanism Debris Guard, P/N 83220012, to remove / prevent chafe damage with the spring assembly</b>			2 RD NUMBER <b>8/4-32-064</b>	
			3 SECTION <b>I</b>	4 SHEET <b>I</b>
5 PRIME DESIGN ACTIVITY <b>BOMBARDIER INC., DOWNSVIEW 71867</b>	6 ADDITIONAL LIMITATIONS <b>NONE</b>	7 SERIES <b>DHC-8-400 Models 401 / 402</b>	8 APPLICABILITY <b>S/N All</b>	

9 DESCRIPTION

The following sheets provide rework instructions for trimming the lower edge of the Nose Landing Gear Door Mechanism Debris Guard, P/N 83220012, to remove / prevent chafe damage with the spring assembly.

The repair involves trimming the lower edge of the debris guard to the maximum limits defined herein, inspecting the reworked edges for any signs of delamination - none permitted, applying epoxy adhesive to re-seal the edge of the panel and re-protecting the reworked areas.

After completion of the repair the debris guard is to be re-installed and the nose landing gear mechanism is to be inspected to ensure that there is no fouling of the spring assembly with the debris guard through the full range of motion.

The details of this repair are covered by RD 8/4-32-064, Section 1:

Sheet 1, Issue 1

Sheet 2, Issue 1

Sheet 3, Issue 1

10 ISSUE	<b>I</b>				
11 DATE	<b>Sep. 24, '07</b>				
12 PREPARED BY	<b>P Bois-Grosstiant</b>				
13 STRESS	<i>R. Mobilio</i>				
16 DESIGN AUTHORITY	<i>R. Mobilio</i>				
14	<b>N/A</b>				
15	<b>N/A</b>				
17 DAO AUTHORITY	<i>P. Bois-Grosstiant</i> <b>339</b> <b>24<sup>th</sup> SEPT. 2007</b>				

18  THE TECHNICAL CONTENT OF THIS DOCUMENT IS APPROVED UNDER THE DESIGN AUTHORITY OF BOMBARDIER CANADA UNDER APPROVED ORGANIZATION NO. 151530

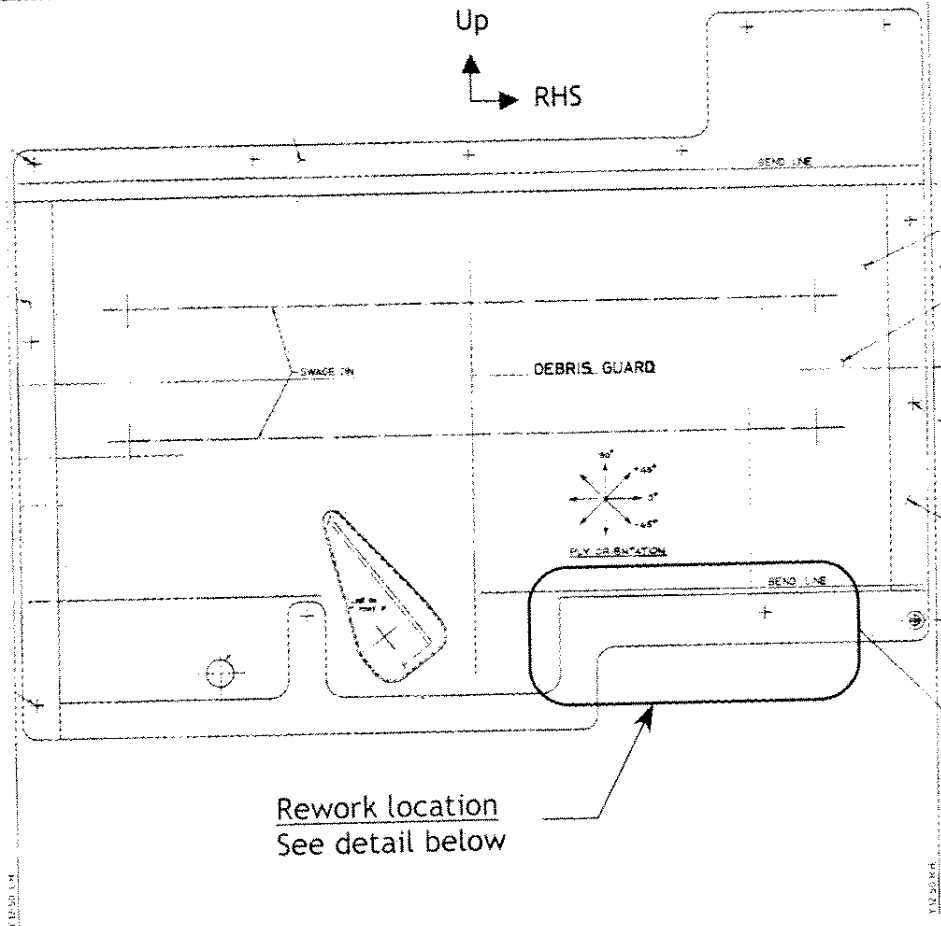
THE MANUFACTURING DISPOSITION OR APPROVAL BY THE FACTORY SUPERVISOR IS NOT AN AUTHORITY

THIS REPAIR DRAWING HAS BEEN APPROVED BY THE BOMBARDIER AUTHORITY (APPROVED TO BOMBARDIER INC. BY THE OPERATOR OR THE USER). IT IS THE RESPONSIBILITY OF THE OPERATOR OR THE USER TO VERIFY THAT THE INFORMATION SUPPLIED IS COMPLETE AND ACCURATE. BOMBARDIER INC. DOES NOT ACCEPT RESPONSIBILITY FOR THE CONSEQUENCE RESULTING FROM INCOMPLETE OR MISLEADING REPORTING OF THE DAMAGE (DISCREPANCY).

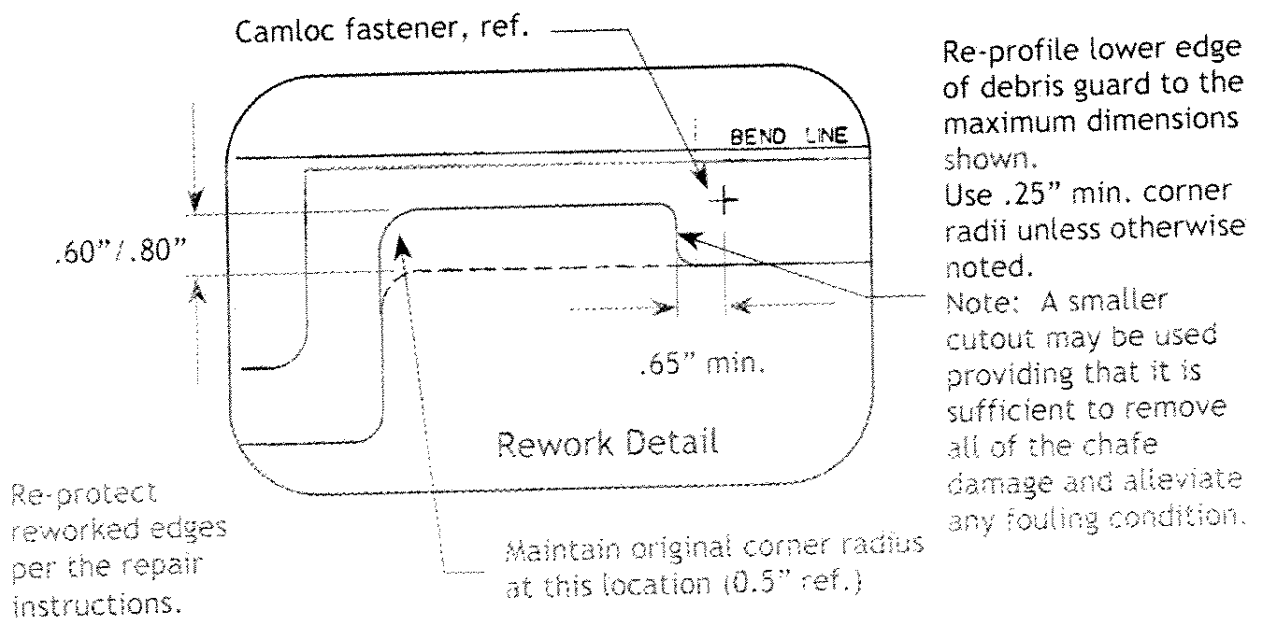
THE INFORMATION CONTAINED HEREIN IS PROPRIETARY AND IS NOT TO BE USED OR DISCLOSED TO OTHERS WITHOUT THE WRITTEN CONSENT OF BOMBARDIER INC. THE RECIPIENT OF THIS DOCUMENT BY ITS RETURN AND USE AGREES TO HOLD IN CONFIDENCE THE TECHNICAL DATA AND DESIGN INFORMATION CONTAINED HEREIN. THIS DRAWING SHALL NOT APPLY TO PERSONS HAVING PROPRIETARY RIGHTS IN SUCH INFORMATION, DESIGN OR DATA TO SUCH EXTENT AS THE EXTENT THAT SUCH RIGHTS EXIST.

0338227 REV 1999 07

10 ISSUE	1				2 RD NUMBER 8/4-32-064	3 SECTION 1	4 SHEET 2
----------	---	--	--	--	---------------------------	----------------	--------------



View looking fwd on debris guard showing location of rework



Re-protect reworked edges per the repair instructions.

Maintain original corner radius at this location (0.5" ref.)

Re-profile lower edge of debris guard to the maximum dimensions shown.  
Use .25" min. corner radii unless otherwise noted.  
Note: A smaller cutout may be used providing that it is sufficient to remove all of the chafe damage and alleviate any fouling condition.

10 ISSUE	1				2 RD NUMBER	3 SECTION	4 SHEET
					8/4-32-064	1	3

### Repair Instructions

1. Re-profile the lower edge of the nose landing gear door mechanism debris guard, P/N 83220012, as shown on Sheet 2.

Maintain maximum cutout dimensions and minimum distance to the adjacent Camloc as shown on Sheet 2. Ensure that all chafe damage is removed by the cutout.

Note: In lieu of the maximum cutout shown on Sheet 2 a smaller cutout may be used provided that the min. corner radii and distance from the Camloc is maintained and that all of the damage has been removed.



2. Perform a detailed visual inspection of the edge of the debris guard to ensure that the reworked area is free of delamination - no delamination permitted.
3. Apply epoxy adhesive, ref. Table 2, Item 13 or 14, per generic RD 8/4-51-030, along the edge of the cutout to re-seal the edge of the debris guard. Allow epoxy adhesive to cure fully and sand lightly as required to obtain a smooth edge.
4. Apply polyurethane enamel in accordance with the instructions of the DASH 8 Structural Repair Manual, PSM 1-84-3, Chapter 51-25-15.
5. Re-install debris guard in accordance with the original engineering drawings or per the applicable task in the aircraft maintenance manual.
6. Inspect the nose landing gear mechanism to ensure that there is no fouling of the spring assembly with the debris guard through the full range of motion.




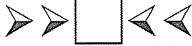

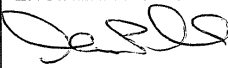

## **Bilag 27B**







		<b>SERVICE CONCESSION REQUEST</b>			SCR NUMBER	REV	PROG
					SCR 101-07	B	2131
AIRCRAFT DETAILS					<b>INDICATE IF A.O.G.</b> 		
EVENT DATE (Y/M/D)	AIRLINE	A/C S/N	TSN	CSN			
2007/09/21	ALL	N/A	N/A	N/A			
<b>ITEM</b>	<b>PART NO.</b>	<b>NAME</b>			<b>S/N</b>	<b>TSN</b>	<b>CSN</b>
N.H.A ⇨							
N.H.A ⇨	47840	LINKAGE ASSEMBLY, FORWARD DOORS, NLG			N/A		
PART ⇨	47844-1	SPRING ASSEMBLY			N/A		
<b>LIMITED FLIGHT REQUESTED</b> YES <input checked="" type="checkbox"/> NO <input type="checkbox"/> (IF YES, AUTHORIZED ENGINEER SIGNATURE REQUIRED)		REQUEST CATEGORY			AFFECTED SYSTEM		
		IN-SERVICE PROBLEM <input checked="" type="checkbox"/>			MLG <input type="checkbox"/>	BRAKING <input type="checkbox"/>	NLG <input checked="" type="checkbox"/>
INDICATE FC OR FH LIMITATION: FC* <u>250</u> FH* _____ *WHICH EVER COMES FIRST		<b>DISPOSITION SUMMARY</b> NORMAL USE AFTER REPAIR <input type="checkbox"/> LIMITED SERVICE <input checked="" type="checkbox"/> TEMPORARY REPAIR <input type="checkbox"/> REMOVE & REPAIR <input type="checkbox"/> REPLACE PART <input checked="" type="checkbox"/>			<b>PREVIOUS CONCESSIONS GRANTED FOR THIS SERIAL NUMBER COMPONENT</b> UNKNWN		
IF ONLY FC IS SPECIFIED INDICATE FH NOT RELEVANT <input checked="" type="checkbox"/> OR SPECIFY LIMITATION IN TERMS OF AIRCRAFT CHECKS: A <input type="checkbox"/> C <input type="checkbox"/> L <input type="checkbox"/> x							
SCR RAISED BY					S.HEALEY		DATE RAISED September 23, 2007

ITEM	PROBLEM DESCRIPTION
1.	NLG FORWAD DOOR SPRING P/N 47844-1 MAY FAIL AND SEPARATE FROM MOUNTINGS PRESENTING A F.O.D ISSUE FOR THE NLG.  SEE SHEET 4 FOR LOCATION INFORMATION.
<b>REPORTED CAUSE OF PROBLEM:</b>	
<b>ADDITIONAL INFORMATION ATTACHED</b> <input checked="" type="checkbox"/>	
<b>SEE SHEET 2 AND SUBS FOR MORE INFORMATION</b>	

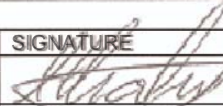


		<b>SERVICE CONCESSION REQUEST</b>			SCR NUMBER	REV	PROG
					SCR 101-07	B	2131
AIRCRAFT DETAILS					INDICATE IF <b>A.O.G.</b> 		
EVENT DATE (Y/M/D)	AIRLINE	A/C S/N	TSN	CSN			
2007/09/21	ALL	N/A	N/A	N/A			
ITEM	PART NO.	NAME			S/N	TSN	CSN
N.H.A ⇨							
N.H.A ⇨	47840	LINKAGE ASSEMBLY, FORWARD DOORS, NLG			N/A		
PART ⇨	47844-1	SPRING ASSEMBLY			N/A		
ITEM	CONTINUATION SHEET / INSTRUCTIONS						
1.	<p>THIS INSPECTION APPLIES TO ALL AIRCRAFT ON A ONE TIME BASIS AS FOLLOWS, AND SHALL REMAIN EFFECTIVE UNTIL NOTICE OF TERMINATION IS PROVIDED BY GOODRICH AND/OR BOMBARDIER.</p> <ul style="list-style-type: none"> <li>- AIRCRAFT HAVING LESS THAN <b>5,000 A/C FC</b> SHALL BE INSPECTED WITHIN <b>500 A/C FC</b>.</li> <li>- AIRCRAFT HAVING BETWEEN <b>5,000 TO 10,000 FC</b> SHALL BE INSPECTED WITHIN <b>300 FC</b>.</li> <li>- AIRCRAFT HAVING OVER <b>10,000 FC</b> SHALL BE INSPECTED WITHIN <b>100 FC</b>.</li> </ul> <ol style="list-style-type: none"> <li>1. WITH GROUND LOCK ENGAGED AND NLG FWD DOOR GROUND LOCK PIN INSTALLED REMOVE SPRING P/N 47844-1 FROM AIRCRAFT (REF. BOMBARDIER AMM).</li> <li>2. INSPECT SPRING RETAINERS P/N 47845-1 FOR EVIDENCE OF DAMAGE, AND ENSURE THAT SPRING WIRE IS TIGHTLY WOUND AROUND RETAINER.</li> <li>3. VISUALLY INSPECT SPRING P/N 47844-1 FOR EVIDENCE OF DAMAGE (NICKS, DENTS SCRATCHES, CHAFING) TO THE SURFACE OF THE WIRE. INSPECTION TO COVER BOTH OUTSIDE AND INSIDE SURFACE OF SPRING.                         <ul style="list-style-type: none"> <li>- IF VISUAL INSPECTION SHOWS EVDIENCE OF DAMAGE THEN PERFORM LPI (REF. OPER #4) IN CRITICAL AREAS AND AREAS OF DAMAGE.</li> <li>- IF VISUAL INSPECTION IS NEGATIVE FOR EVIDENCE OF DAMAGE PERFORM LPI (REF.OPER #4) IN CRITICAL AREAS ONLY.</li> </ul> </li> <li>4. LIQUID PENETRANT INSPECT CRITICAL AREAS AND AREAS OF DAMAGE (REF. OPER #3) PER ASTM E-1417, TYPE 1, SENSITVITY LEVEL 3. DEFECTS NOT TO EXCEED MIL-STD-1907, GRADE 'A' LIMITS.                         <ul style="list-style-type: none"> <li>- IF DEFECTS ARE FOUND DURING THIS INSPECTION DISCARD SPRING ASSEMBLY.</li> </ul> </li> </ol>						
	NAME (PRINT)	SIGNATURE	DATE(Y/M/D)	AUTHORIZED ENGINEER OR HIGHER ENGINEERING AUTHORITY			
ENGINEER	S.HEALEY		2007/09/24	 DATE: Sept 24, 2007			
STRESS	N/A						
OTHER (SPECIFY)	M.PERRELLA		2007/09/24				
							<b>Page 2 of 5</b>


		<b>SERVICE CONCESSION REQUEST</b>			SCR NUMBER	REV	PROG
					SCR 101-07	B	2131
AIRCRAFT DETAILS					<b>INDICATE IF</b> <b>A.O.G.</b> 		
EVENT DATE (Y/M/D)	AIRLINE	A/C S/N	TSN	CSN			
2007/09/21	ALL	N/A	N/A	N/A			
<b>ITEM</b>	<b>PART NO.</b>	<b>NAME</b>			<b>S/N</b>	<b>TSN</b>	<b>CSN</b>
N.H.A ⇨							
N.H.A ⇨	47840	LINKAGE ASSEMBLY, FORWARD DOORS, NLG			N/A		
PART ⇨	47844-1	SPRING ASSEMBLY			N/A		

**INSTRUCTIONS / CONTINUATION SHEET**

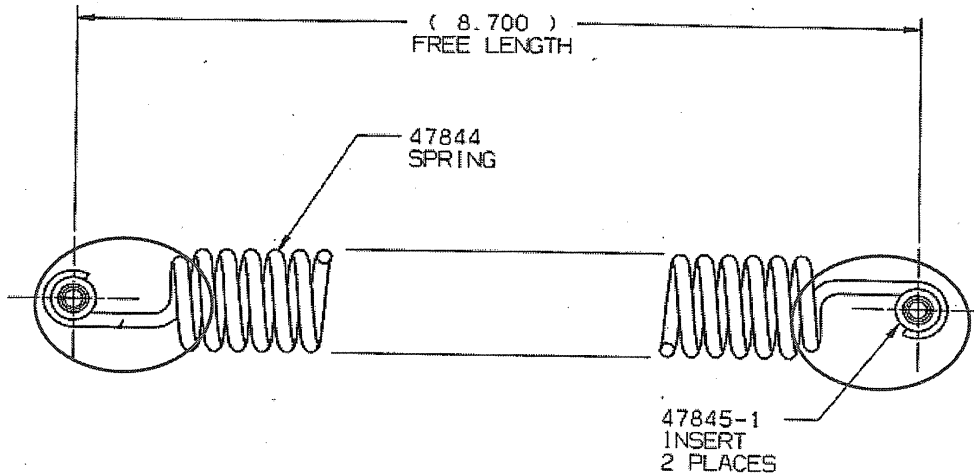
5. IF DAMAGE IS IDENTIFIED IN OPER #3, AND PART MEETS ACCEPTANCE CRITERIA OF OPER #4 (LPI), LIGHTLY POLISH AREAS SHOWING EVDIENCE OF SCRATCHES OR CHAFE DAMAGE AS REQUIRED TO JUST REMOVE ALL SHARP EDGES, NO POWER TOOLS PERMITTED.
  - DO NOT DEEPEN
  - MAX DEPTH OFDAMAGE NOT TO EXCEED .006 INCH.
  - IF MAX DEPTH EXCEEDED DISCARD PART.
6. ENGINEERING EVALUATION SHOWS ANY/ALL SPRINGS REWORKED IN ACCORDANCE WITH OPERATION 7, AND/OR HAVING LONGITUDINAL PLAY BETWEEN THE RETAINER AND SPRING ARE ACCEPTABLE FOR **250 A/C FC** OF CONTINUED SERVICE. WHEN FLIGHT CYCLE ALLOWANCE IS EXHAUSTED, DISCARD SPRING ASSEMBLY.
7. REASSEMBLE FWD DOOR LINKAGE WITH NEW OR SERVICABLE SPRING P/N 47844-1, AND RIG ACCORDING TO BOMBARDIER AMM PROCEDURES.
8. PERFORM ANY/ALL RETURN TO SERVICE ACTIONS IN ACCORDANCE WITH BOMBARDIER AMM.

**NOTE:** FURTHER INFORMATION REGARDING REPEAT INSPECTIONS OF THE NLG FORWARD DOOR SPRING ASSEMBLY TO FOLLOW IN A FURTHER REVISION OF THIS DOCUMENT, AS/IF REQUIRED.

DISPOSITION AUTHORIZATION				
	NAME (PRINT)	SIGNATURE	DATE(Y/M/D)	AUTHORIZED ENGINEER OR HIGHER ENGINEERING AUTHORITY
ENGINEERING	S.HEALEY		2007/09/24	 DATE: Sept 24, 2007
STRESS	N/A			
OTHER (SPECIFY)	M.PERRELLA		2007/09/24	
				<b>Page 3 of 5</b>


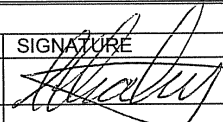
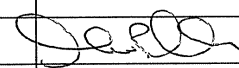
		<b>SERVICE CONCESSION REQUEST</b>			SCR NUMBER	REV	PROG
					SCR 101-07	B	2131
AIRCRAFT DETAILS					INDICATE IF <b>A.O.G.</b> >> <input type="checkbox"/> <<		
EVENT DATE (Y/M/D)	AIRLINE	A/C S/N	TSN	CSN			
2007/09/21	ALL	N/A	N/A	N/A			
ITEM	PART NO.	NAME			S/N	TSN	CSN
N.H.A ⇨							
N.H.A ⇨	47840	LINKAGE ASSEMBLY, FORWARD DOORS, NLG			N/A		
PART ⇨	47844-1	SPRING ASSEMBLY			N/A		

INSTRUCTIONS / CONTINUATION SHEET

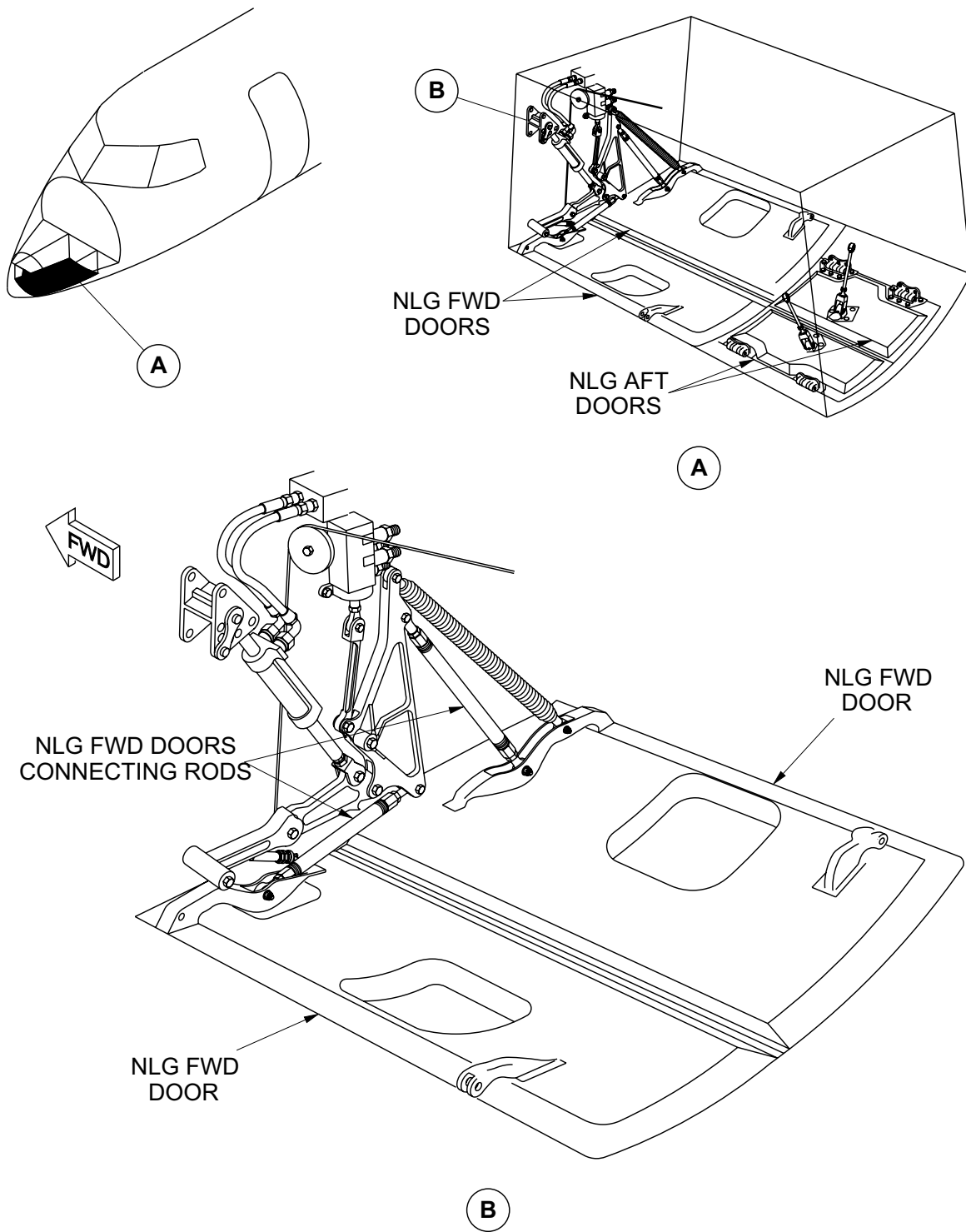


**FIGURE 1.**

CRITICAL AREAS FOR VISUAL INSPECTION AND LIQUID PENETRANT INSPECTION ARE HIGHLIGHTED ABOVE.

DISPOSITION AUTHORIZATION				AUTHORIZED ENGINEER OR HIGHER ENGINEERING AUTHORITY    DATE: Sept 24, 2007
	NAME (PRINT)	SIGNATURE	DATE(Y/M/D)	
ENGINEERING	S.HEALEY		2007/09/24	
STRESS	N/A			
OTHER (SPECIFY)	M.PERRELLA		2007/09/24	
				<b>Page 4 of 5</b>

AIRCRAFT MAINTENANCE MANUAL



Nose Landing Gear Doors – Component Location

Figure 101 (Sheet 1 of 2)

MA025A01



## **Bilag 28**







2007-09-27

STK 2007-0280-4

De skandinaviska luftfartsmyndigheternas  
samarbetsorgan för flygsäkerhetsfrågor

**STK** DET SKANDINAVISKE TILSYNSKONTOR  
DENMARK NORWAY SWEDEN

Accountable manager  
John Dueholm  
Scandinavian Airlines System  
Denmark-Norway-Sweden  
STODA

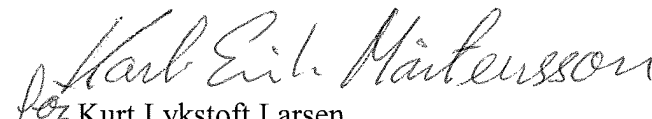
Kopia:  
STOOM  
STOOG  
STOOF  
STODO-X  
STODG

### **Krævet inspektion af næse landingsstellet på luftfartøjer af typen Bombardier DHC8-Q400.**

I fortsættelse af OPS-udvalgets brev af 20. september 2007 vedrørende betingelserne for genaktivering af luftdygtighedsbeviserne for SAS opererede luftfartøjer af ovennævnte type, kræves inspektion af næsestellet som anført i Bombardier AOM249B eller senere godkendte udgave udført før videre flyvning.

Kravet skal ses i lyset af havariet med et tysk registreret luftfartøj af samme type den 21. september 2007 i München, og har således ingen relation til havarierne i Aalborg og Vilnius, hvor højre hovedunderstel kollapsede.

På vegne af luftfartsmyndighederne i Danmark, Norge och Sverige.

  
for Kurt Lykstoff Larsen  
Ordförande OPS-utvalget

STK - Det Skandinaviske Tilsynskontor  
Luftfartsstyrelsen  
SE-601 73 NORRKÖPING  
Visiting address: Bergkällavägen 32  
SOLLENTUNA, Sweden

Phone  
+ 46 (0)11 41 52100

E-mail: [stk@luftfartsstyrelsen.se](mailto:stk@luftfartsstyrelsen.se)  
SITA CODE BMAZVSK

Facsimile  
+ 46 (0)11 41 52490



## **Bilag 29**



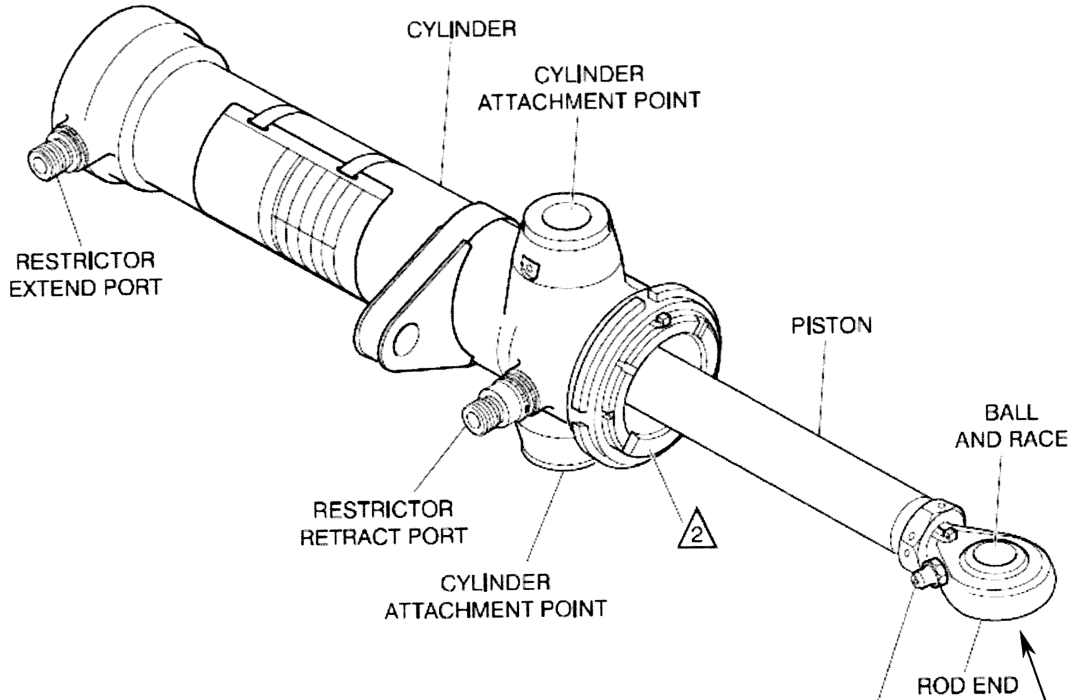
# BOMBARDIER

## REPAIR DRAWING (RD)

1 TITLE <b>Inspection procedure for retraction actuators p/n 46550-7 or 46550-9 rod end.</b>			2 RD NUMBER <b>8/4-32-059</b>		
			3 SECTION <b>1</b>	4 SHEET <b>1</b>	
5 PRIME DESIGN ACTIVITY <b>BOMBARDIER INC., DOWNSVIEW 71867</b>	6 ADDITIONAL LIMITATIONS <b>NONE</b>	7 SERIES <b>DHC-8-400</b>	8 APPLICABILITY <b>Models 400, 401 and 402</b>		
9 DESCRIPTION  <p><b><u>This page re-written at Issue #5.</u></b>-SCR086-07 raised to Rev. D</p> <p>This RD defines an inspection procedure for retraction actuators p/n 46550-7 or 46550-9 rod end.</p> <p>This RD is to be accomplished in conjunction with Goodrich SCR 086-07 rev. D.</p> <p>The procedure involves removing the rod end of the retraction actuator assembly in accordance with SCR 086-07 rev. D and inspecting affected parts for any signs of corrosion or wear.</p> <p><b>Provided the components are free of any damage re-assemble retraction actuator in accordance with SCR 086-07 rev. D.</b></p> <p>The details of this procedure are covered by RD 8/4-32-059 section 1.</p> <p style="text-align: right;">Sheet 1 Issue 5 Sheet 2 Issue 5</p> <p><b>At SCR 086-07 Rev D: Rework for Freeze fit Pin in SCR now deleted-Ref. Dwg S2117-deleted. New Inspection criteria added for reworked Actuators (excluding those repaired by Section B) Page 1,2 raised to Issue # 5.</b></p>					
10 ISSUE	<b>5</b>				
11 DATE	<b>20-Sep-07</b>				
12 PREPARED BY	<b>D. Devogel</b>				
13 STRESS	<i>[Signature]</i>				
16 DESIGN AUTHORITY	<i>[Signature]</i> #233 20 SEP 2007				
14					
15 DAO AUTHORITY	<i>[Signature]</i> #233 20 SEP 2007				
17 DAO AUTHORITY	<i>[Signature]</i> #233 20 SEP 2007				
18	<input checked="" type="checkbox"/> THE TECHNICAL CONTENT OF THIS DOCUMENT IS APPROVED UNDER THE DESIGN AUTHORITY OF TRANSPORT CANADA DESIGN APPROVAL ORGANIZATION DAO NO. 93-Q-02			<input type="checkbox"/> BA ENGINEERING DISPOSITION FOR APPROVAL BY OPERATOR'S LOCAL AIRWORTHINESS AUTHORITY	
THIS REPAIR DRAWING HAS BEEN PREPARED ON THE BASIS OF INFORMATION SUPPLIED TO BOMBARDIER INC. BY THE OPERATOR OR HIS AGENT. IT IS THE RESPONSIBILITY OF THE OPERATOR OR HIS AGENT TO VERIFY THAT THE INFORMATION SUPPLIED IS COMPLETE AND ACCURATE. BOMBARDIER INC. DOES NOT ACCEPT RESPONSIBILITY FOR ANY CONSEQUENCE RESULTING FROM INCOMPLETE OR INACCURATE REPORTING OF THE DAMAGE/DISCREPANCY.			THE INFORMATION, TECHNICAL DATA AND DESIGNS DISCLOSED HEREIN ARE THE EXCLUSIVE PROPERTY OF BOMBARDIER INC. OR CONTAIN PROPRIETARY RIGHTS OF OTHERS AND ARE NOT TO BE USED OR DISCLOSED TO OTHERS WITHOUT THE WRITTEN CONSENT OF BOMBARDIER INC. THE RECIPIENT OF THIS DOCUMENT, BY ITS RETENTION AND USE AGREES TO HOLD IN CONFIDENCE THE TECHNICAL DATA AND DESIGNS CONTAINED HEREIN. THE FOREGOING SHALL NOT APPLY TO PERSONS HAVING PROPRIETARY RIGHTS TO SUCH INFORMATION, TECHNICAL DATA OR SUCH DESIGNS TO THE EXTENT THAT SUCH RIGHTS EXIST.		

10 ISSUE	5				2 RD NUMBER	3 SECTION	4 SHEET
					8/4-32-059	1	2

## Retraction actuator assembly p/n 46550-7/-9



Remove the rod end of the retraction actuator assembly in accordance with SCR 086-07 rev. D

Inspect affected parts for any signs of corrosion or wear.

Provided the components are free of any damage re-assemble retraction actuator in accordance with SCR 086-07 rev. D

At Issue # 5: SCR086-07 Raised to Rev D from C

## **Bilag 30**





## Bombardier Q400

### All Operator Message No. 243

---

ATTN: Director/Manager of: Maintenance  
Engineering  
Quality Control  
Flight Operations  
Procurement/Spares

DATE: 14 Sep 07

ATA: 3210 MODEL: Q400

SUBJECT: RD 8/4-32-059 Revision 4 for Transport Canada AD CF-2007-20 Issued Against  
DHC-8-400 Main Landing Gear

REFERENCE: /A/ AOM 242 RD 8/4-32-059 Revision 3 for Transport Canada AD CF-2007-20  
Issued Against DHC-8-400 Main Landing Gear

The following message is being sent to all Bombardier Q400 Operators and Bombardier Regional Aircraft Field Service Representatives.

This message contains information requiring attention and/or action. Please ensure timely and appropriate distribution within maintenance and flight operations departments.

---

#### DISCUSSION:

This AOM is being issued to inform Operators of the release of Repair Drawing (RD) 8/4-32-059 Issue 4 required for compliance to Transport Canada Airworthiness Directive (AD) No. CF-2007-20.

Issue 4 of RD 8/4-32-059 is being revised with clarifications as requested by TC in item 10 on page 3, and 4B) On page 5.

Operators having complied with Issue 1 of RD 8/4-32-059 with no findings are not required to repeat the inspections specified in Issue 2, 3 or 4.

Please direct responses and inquiries to the Technical Help Desk in Toronto at telephone (416) 375-4000 or facsimile (416) 375-4539 or e-mail: [thd.qseries@aero.bombardier.com](mailto:thd.qseries@aero.bombardier.com)

Alisa Turk, Manager, Technical Help Desk and Martin Elliott, Director, In-Service Engineering & Technical Support, Bombardier Regional Aircraft.



## **Bilag 30A**



# BOMBARDIER

## REPAIR DRAWING (RD)

1 TITLE Inspection procedure for retraction actuators p/n 46550-7 or 46550-9 rod end.			2 RD NUMBER 8/4-32-059	
			3 SECTION 1	4 SHEET 1
5 PRIME DESIGN ACTIVITY BOMBARDIER INC., DOWNSVIEW 71867	6 ADDITIONAL LIMITATIONS NONE	7 SERIES DHC-8-400	8 APPLICABILITY Models 400, 401 and 402	

### 9 DESCRIPTION

This RD defines an inspection procedure for retraction actuators p/n 46550-7 or 46550-9 rod end.

This RD is to be accomplished in conjunction with Goodrich SCR 086-07 rev. ~~A, B, C~~ <sup>(2) (3) (4)</sup>

The procedure involves removing the rod end of the retraction actuator assembly in accordance with SCR 086-07 rev. ~~A~~ and inspecting affected parts for any signs of corrosion or wear.

No corrosion or wear damage is allowed, <sup>(2)</sup> ~~EXCEPT AS PERMITTED IN SCR 086-07 REV. ~~A, B, C~~~~ <sup>(3) (4)</sup>

Provided the components are free of any damage re-assemble retraction actuator in accordance with SCR 086-07 rev. ~~A, B, C~~ <sup>(2) (3) (4)</sup>

The details of this procedure are covered by RD 8/4-32-059 section 1.

Sheet 1 Issue ~~XZ B 4~~  
Sheet 2 Issue ~~XZ B 4~~

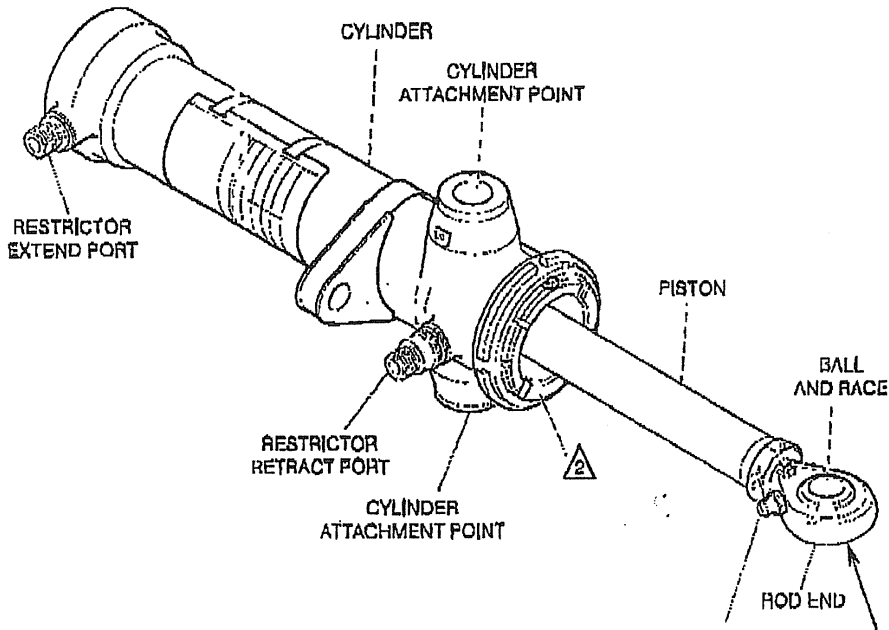
*At Iss. 2: SCR REF CHANGED TO REV. A, WAS REV. NC*

10 ISSUE	1	2	3	4
11 DATE	12-Sep-07	13-SEP-07	13-SEP-07	14-Sep-07
12 PREPARED BY	A. Vinitzky	A. VINITZKY	A. TURK	A. TURK
13 STRESS	N/A	<del>SC</del>	<del>SC</del>	<del>SC</del>
16 DESIGN AUTHORITY	M. BABIN	M. BABIN	M. BABIN	<del>M. BABIN</del>
14	N/A			
15	N/A			
17 DAO AUTHORITY	12 Sept 2007	13 Sept 2007	13 Sept 2007	14 Sept 2007

18	<input checked="" type="checkbox"/> THE TECHNICAL CONTENT OF THIS DOCUMENT IS APPROVED UNDER THE DESIGN AUTHORITY OF TRANSPORT CANADA DESIGN APPROVAL ORGANIZATION DAO NO. 83-11-02	<input type="checkbox"/> BA ENGINEERING DISPOSITION FOR APPROVAL BY OPERATOR'S LOCAL AIRWORTHINESS AUTHORITY
	<p><small>THIS REPAIR DRAWING HAS BEEN PREPARED ON THE BASIS OF INFORMATION SUPPLIED TO BOMBARDIER INC. BY THE OPERATOR OR HIS AGENT. IT IS THE RESPONSIBILITY OF THE OPERATOR OR HIS AGENT TO VERIFY THAT THE INFORMATION SUPPLIED IS COMPLETE AND ACCURATE. BOMBARDIER INC. DOES NOT ACCEPT RESPONSIBILITY FOR ANY CONSEQUENCE RESULTING FROM INCOMPLETE OR INACCURATE REPORTING OF THE DAMAGE/DISCREPANCY.</small></p> <p><small>THE INFORMATION, TECHNICAL DATA AND DESIGNS DISCLOSED HEREIN ARE THE EXCLUSIVE PROPERTY OF BOMBARDIER INC. OR CONTAIN PROPRIETARY RIGHTS OF OTHERS AND ARE NOT TO BE USED OR DISCLOSED TO OTHERS WITHOUT THE WRITTEN CONSENT OF BOMBARDIER INC. THE RECEIPT OF THIS DOCUMENT, BY ITS RETENTION AND USE AGREES TO HOLD IN CONFIDENCE THE TECHNICAL DATA AND DESIGNS CONTAINED HEREIN. THE FOREGOING SHALL NOT APPLY TO PERSONS HAVING PROPRIETARY RIGHTS TO SUCH INFORMATION, TECHNICAL DATA OR SUCH DESIGNS TO THE EXTENT THAT SUCH RIGHTS EXIST.</small></p>	

10 ISSUE	1	2	3	4	2 RD NUMBER	3 SECTION	4 SHEET
					8/4-32-059	1	2

Retraction actuator assembly p/n 46550-7/9



Remove the rod end of the retraction actuator assembly in accordance with SCR 086-07 rev. ~~A~~ ~~B~~ **C**

Inspect affected parts for any signs of corrosion or wear.

No corrosion or wear damage is allowed, *EXCEPT AS NOTED IN SCR 086-07 REV. ~~A~~ ~~B~~ C*


Provided the components are free of any damage re-assemble retraction actuator in accordance with SCR 086-07 rev. ~~A~~ ~~B~~ **C**

- ②
- ③
- ④



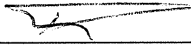
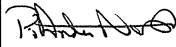
## **Bilag 30B**






		<b>SERVICE CONCESSION REQUEST</b>			SCR NUMBER SCR 086-07	REV C	PROG 2130
		AIRCRAFT DETAILS			INDICATE IF <b>A.O.G.</b> ➤➤ <input checked="" type="checkbox"/> ⬅️⬅️		
EVENT DATE (Y/M/D)	AIRLINE	A/C S/N	TSN	CSN			
ANY	ALL	4001 AND SUB					
ITEM	PART NO.	NAME		S/N	TSN	CSN	
N.H.A ⇨							
N.H.A ⇨	46550-7I-9	RETRACTION ACTUATOR		ALL			
PART ⇨	46570-1I-3	PISTON		ALL			
<b>LIMITED FLIGHT REQUESTED</b> YES <input checked="" type="checkbox"/> NO <input type="checkbox"/> (IF YES, AUTHORIZED ENGINEER SIGNATURE REQUIRED)		REQUEST CATEGORY			AFFECTED SYSTEM		
		IN-SERVICE PROBLEM <input checked="" type="checkbox"/>			MLG <input checked="" type="checkbox"/>	BRAKING	<input type="checkbox"/>
INDICATE FC OR FH LIMITATION:		<b>DISPOSITION SUMMARY</b> NORMAL USE AFTER REPAIR <input checked="" type="checkbox"/> LIMITED SERVICE <input checked="" type="checkbox"/> TEMPORARY REPAIR <input type="checkbox"/> REMOVE & REPAIR <input checked="" type="checkbox"/> REPLACE PART <input checked="" type="checkbox"/>			NLG <input type="checkbox"/>	STEERING	<input type="checkbox"/>
<b>FC* 1000 OR 6 MONTHS</b> *WHICH EVER COMES FIRST					<b>PREVIOUS CONCESSIONS GRANTED FOR THIS SERIAL NUMBER COMPONENT</b>		
IF ONLY FC IS SPECIFIED INDICATE FH NOT RELEVANT <input type="checkbox"/>							
OR SPECIFY LIMITATION IN TERMS OF AIRCRAFT CHECKS: A <input type="checkbox"/> C <input type="checkbox"/> L <input type="checkbox"/> x					FLTC <input type="checkbox"/>	OTHER	<input type="checkbox"/>
SCR RAISED BY B WEBER					DATE RAISED 2007/09/12		

ITEM	PROBLEM DESCRIPTION
1	THERE HAVE BEEN 2 INSTANCES OF SEPARATION OF ROD END P/N P3A2750 AND PISTON P/N 46570-1I-3. INSPECTION OF THREAD CONDITION REQUIRED IN ACCORDANCE TO TRANSPORT CANADA AIRWORTHINESS DIRECTIVE (CF-2007-20).
REPORTED CAUSE OF PROBLEM:	
ADDITIONAL INFORMATION ATTACHED <input type="checkbox"/>	
➤➤ SEE SHEET 2 AND SUBS FOR MORE INFORMATION ⬅️⬅️	
<b>Page 1 of 7</b>	

		<b>SERVICE CONCESSION REQUEST</b>			SCR NUMBER SCR 086-07	REV C	PROG 2130
		AIRCRAFT DETAILS			INDICATE IF <b>A.O.G.</b> 		
EVENT DATE (Y/M/D)	AIRLINE	A/C S/N	TSN	CSN			
ANY	ALL	4001 AND SUB					
<b>ITEM</b>	<b>PART NO.</b>	<b>NAME</b>			<b>S/N</b>	<b>TSN</b>	<b>CSN</b>
N.H.A ⇨							
N.H.A ⇨	46550-7/-9	RETRACTION ACTUATOR			ALL		
PART ⇨	46570-1/-3	PISTON			ALL		
ITEM	CONTINUATION SHEET / INSTRUCTIONS						
1	<ol style="list-style-type: none"> <li>1. SHUT DOWN HYDRAULIC SYSTEM 2</li> <li>2. WITH ACTUATOR INSTALLED ON AIRCRAFT, REMOVE LOCK WIRE AND BACK OFF JAM NUT AS REQUIRED TO DISENGAGE LOCKING FEATURE.</li> <li>3. DISASSEMBLE AS REQUIRED, REMOVE ACTUATOR ROD END PIN (P/N 46160-1) FROM MAIN LANDING GEAR SHOCK STRUT ASSEMBLY</li> <li>4. FULLY COMPRESS PISTON</li> <li>5. SECURE PISTON, AND REMOVE ROD END FROM PISTON.</li> <li>6. IF ROD END (P/N P3A2750) DOES NOT EASILY BACK OUT OF PISTON WITHOUT BINDING AND WITH THE USE OF A STRAP WRENCH, REMOVE RETRACT ACTUATOR P/N 46550-7/-9 FROM GEAR ASSEMBLY. <ul style="list-style-type: none"> <li>- REPLACE WITH NEW OR REFURBISHED RETRACT ACTUATOR P/N 46550-7/-9 IN ACCORDANCE WITH BOMBARDIER AMM. REPLACEMENT ACTUATOR TO HAVE INCORPORATED CORROSION INHIBITING COMPOUND (CIC).</li> <li>- IF ACTUATOR DOES NOT HAVE CORROSION INHIBITING COMPOUND (CIC) WITHIN 500 FC OF INITIAL INSPECTION, INCORPORATED SEE <b>SECTION A</b> OF THIS SCR.</li> </ul> </li> <li>7. IF ROD END (P/N P3A2750) BACKS OUT OF PISTON WITHOUT BINDING, COMPLETELY REMOVE ROD END AND CONTINUE WITH OPERATIONS 8 THRU 16.</li> <li>8. WIRE BRUSH WITH SOLVENT TO CLEAN THREADED AREAS OF PISTON AND ROD.</li> <li>9. VISUALLY INSPECT ROD END (P/N P3A2750) FOR EVIDENCE OF CORROSION CONTAMINATION IN THREADS UNDER ADEQUATE LIGHTING CONDITIONS. <ul style="list-style-type: none"> <li>- IF ANY EVIDENCE OF PITTING CORROSION IS FOUND ON ROD END THEN DISCARD THE ROD END.</li> </ul> </li> </ol>						
<b>DISPOSITION AUTHORIZATION</b>							
	NAME (PRINT)	SIGNATURE	DATE(Y/M/D)	AUTHORIZED ENGINEER OR HIGHER ENGINEERING AUTHORITY   DATE: <b>Sept 14, 2007</b>			
ENGINEER	RAMAN MALIK		2007/09/14				
STRESS	A. NORTH		2007/09/14				
OTHER (SPECIFY)	M. PERRELLA		2007/09/14				
				<b>Page 2 of 7</b>			

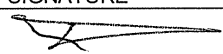

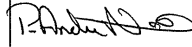
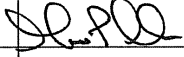
		<b>SERVICE CONCESSION REQUEST</b>			SCR NUMBER SCR 086-07	REV C	PROG 2130
		AIRCRAFT DETAILS			INDICATE IF <b>A.O.G.</b> ➤ ➤ ☒ ☐ ☐ ☐		
EVENT DATE (Y/M/D)	AIRLINE	A/C S/N	TSN	CSN			
ANY	ALL	4001 AND SUB					
<b>ITEM</b>	<b>PART NO.</b>	<b>NAME</b>			<b>S/N</b>	<b>TSN</b>	<b>CSN</b>
N.H.A ⇨							
N.H.A ⇨	46550-7/-9	RETRACTION ACTUATOR			ALL		
PART ⇨	46570-1/-3	PISTON			ALL		


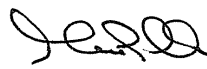
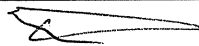
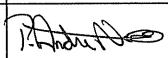
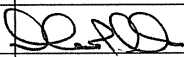
**INSTRUCTIONS / CONTINUATION SHEET**


10. VISUALLY INSPECT PISTON (P/N 46570-1/-3) THREADS AND THREAD RELIEF AREA FOR EVIDENCE OF CORROSION AND/OR DAMAGE AND/OR PITTING (REF. FIGURE 1), USING 10X MAGNIFICATION MIRROR OR BORESCOPE UNDER ADEQUATE LIGHTING CONDITIONS.
  - IF CORROSION IS FOUND IN THREADED AREA OF PISTON P/N 46570-1/-3 PERFORM REWORK IN ACCORDANCE WITH **SECTION B** OF THIS SCR
  - IF NO CORROSION IS FOUND CONTINUE WITH REMAINING OPERATIONS

IF THE INITIAL VISUAL INSPECTION IS DONE WITHOUT USING 10X MAGNIFICATION PER THE REVISION NC OF THIS SCR, A ONE TIME DEFERRAL MAY BE GRANTED FOR UP TO **500 FC**.
11. COAT ACTUATOR THREADS AND THREAD RELIEF AS WELL AS ROD END THREADS, WITH CORROSION INHIBITING COMPOUND MASTINOX 6856K OR CORBAN 27L WITHIN 500 FC OF INITIAL INSPECTION.
12. RE-INSTALL ROD END AND JAM NUT INTO PISTON ASSY
13. DISASSEMBLE AS REQUIRED TO REMOVE ACTUATOR FROM YOKE ASSEMBLY (NOTE: HYDRAULIC DISCONNECTION NOT REQUIRED).
14. USING TOOL NUMBER CG 56806, ADJUST ROD END RETRACTED LENGTH AS REQUIRED, TORQUE JAM NUT TO 660-980 IN-LBS, SAFETY LOCK WIRE PER MS 33540. (FOR DOWEL PIN SOLUTION PER DRAWING S2117, PRIOR TO RIGGING THE ACTUATOR LUBRICATE THE PISTON IN AREA ADJACENT TO THE ROD END WITH SKYDROL)
  - OPTIONAL PROCEDURE FOR RIGGING ACTUATOR LENGTH: RIG ACTUATOR TO NOMINAL RETRACTED LENGTH PER TOOL DRAWING (REF DIM 4.286 INCH) AND TORQUE JAM NUT TO 660-980 IN-LBS, SAFETY LOCK WIRE PER MS33540.
  - NOTE: IF OPTIONAL PROCEDURE IS USED, GEAR SWINGS ARE REQUIRED (2 POWDERED CYCLES AND 1 ALTERNATE RELEASE TO VERIFY FUNCTIONAL CAPABILITY).

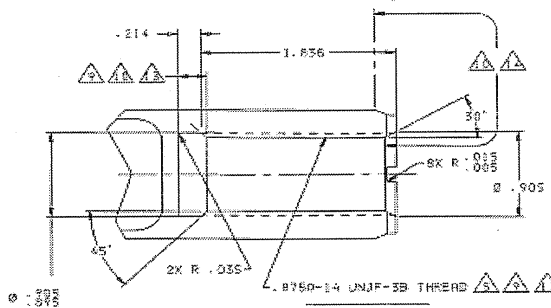
**DISPOSITION AUTHORIZATION**

	NAME (PRINT)	SIGNATURE	DATE(Y/M/D)	AUTHORIZED ENGINEER OR HIGHER ENGINEERING AUTHORITY
ENGINEERING	RAMAN MALIK		2007/09/14	 DATE: Sept 14, 2007
STRESS	A. NORTH		2007/09/14	
OTHER (SPECIFY)	M. PERRELLA		2007/09/14	
				<b>Page 3 of 7</b>

		<b>SERVICE CONCESSION REQUEST</b>			SCR NUMBER SCR 086-07	REV C	PROG 2130
		AIRCRAFT DETAILS			INDICATE IF <b>A.O.G.</b> ➤➤☒☐☐☐➤		
EVENT DATE (Y/M/D)	AIRLINE	A/C S/N	TSN	CSN			
ANY	ALL	4001 AND SUB					
<b>ITEM</b>	<b>PART NO.</b>	<b>NAME</b>			<b>S/N</b>	<b>TSN</b>	<b>CSN</b>
N.H.A ⇨							
N.H.A ⇨	46550-7/-9	RETRACTION ACTUATOR			ALL		
PART ⇨	46570-1/-3	PISTON			ALL		
<b>INSTRUCTIONS / CONTINUATION SHEET</b>							
<p>15. RE-INSTALL ACTUATOR ONTO YOKE ASSEMBLY.</p> <p>16. EXTEND PISTON AND RE-ATTACH TO SHOCK STRUT ASSEMBLY USING PIN P/N 46160-1, AND TORQUE IN ACCORDANCE AMM REQUIREMENTS.</p> <p><b><u>SECTION A – APPLICABLE TO EXISTING ACTUATORS ASSEMBLED WITHOUT CIC</u></b></p> <ol style="list-style-type: none"> <li>DISASSEMBLE AS REQUIRED TO REMOVE ROD END P/N P3A2750 FROM ACTUATOR ASSEMBLY.</li> <li>INSPECT - ENSURE NO EVIDENCE OF CORROSION ON ACTUATOR PISTON THREADS OR ROD END THREADS.</li> <li>COAT ACTUATOR THREADS AND THREAD RELIEF AS WELL AS ROD END THREADS, WITH CIC MASTINOX 6856K OR CORBAN 27L, AND RE-INSTALL ROD END ONTO ACTUATOR ASSEMBLY.</li> <li>ADJUST ACTUATOR RETRACTED LENGTH USING TOOL CG 56806 REQUIREMENTS OR IN ACCORDANCE WITH CMM 32-31-06 REQUIREMENTS. OPTIONAL PROCEDURE PER STEP 13, ABOVE, IS ALSO ACCEPTABLE</li> <li>TORQUE JAM NUT TO 660-980 IN-LBS AND SAFETY LOCKWIRE PER MS 33540.</li> </ol>							
<b>DISPOSITION AUTHORIZATION</b>							
	NAME (PRINT)	SIGNATURE	DATE(Y/M/D)	AUTHORIZED ENGINEER OR HIGHER ENGINEERING AUTHORITY  DATE: Sept 14, 2007			
ENGINEERING	RAMAN MALIK		2007/09/14				
STRESS	A. NORTH		2007/09/14				
OTHER (SPECIFY)	M. PERRELLA		2007/09/14				
				<b>Page 4 of 7</b>			

		<b>SERVICE CONCESSION REQUEST</b>			SCR NUMBER	REV	PROG
					SCR 086-07	C	2130
AIRCRAFT DETAILS					INDICATE IF <b>A.O.G.</b> >> ☒ <<		
EVENT DATE (Y/M/D)	AIRLINE	A/C S/N	TSN	CSN			
ANY	ALL	4001 AND SUB					
ITEM	PART NO.	NAME			S/N	TSN	CSN
N.H.A ⇨							
N.H.A ⇨	46550-7/-9	RETRACTION ACTUATOR			ALL		
PART ⇨	46570-1/-3	PISTON			ALL		

**INSTRUCTIONS / CONTINUATION SHEET**

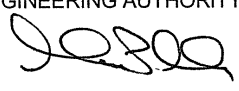
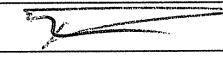
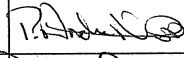
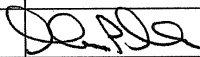



**FIGURE 1**

**SECTION B**

1. MASK AS REQUIRED TO PROTECT ACTUATOR HOUSING, GLAND AREA, AND EXPOSED CHROME OF PISTON FROM F.O.D CONTAMINATION AND DAMAGE DURING THE FOLLOWING REWORK.
2. CHASE PISTON THREADS AND THREAD RELIEF AREA TO REMOVE CORROSION PRODUCTS TO THE GREATEST POSSIBLE EXTENT USING THREAD COMB AND/OR STAINLESS STEEL WIRE BRUSH.
3. INSPECT THE ENTIRE PROFILE OF THREADS OVER THE FULL SPAN OF THREADS (REF. 1.836 DIM, FIGURE 1) AND THE RELIEF GROOVE IN PISTON USING 10X MAGNIFICATION MIRROR OR BORESCOPE UNDER ADEQUATE LIGHTING CONDITIONS.
4. **ACCEPTANCE CRITERIA/REWORK OPTIONS**
  - A) LIGHT SURFACE CORROSION (NO PITTING) OVER THE ENTIRE THREADED LENGTH WITH AT LEAST FIVE CONSECUTIVE FULL UNDAMAGED THREADS WITHIN THE ENGAGED THREAD LENGTH (REF FIGURE 2) IS ACCEPTABLE FOR **1000 FC OR 6 MONTHS** (WHICH EVER OCCURS FIRST) OF CONTINUED SERVICE. THE RETRACT ACTUATOR IS TO BE INSPECTED TO ENSURE JAM NUT IS SECURE AND WIRE LOCK IS IN PLACE EVERY **100 FC**

**DISPOSITION AUTHORIZATION**

	NAME (PRINT)	SIGNATURE	DATE(Y/M/D)	AUTHORIZED ENGINEER OR HIGHER ENGINEERING AUTHORITY  DATE: Sept 14, 2007
ENGINEERING	RAMAN MALIK		2007/09/14	
STRESS	A. NORTH		2007/09/14	
OTHER (SPECIFY)	M. PERRELLA		2007/09/14	
				<b>Page 5 of 7</b>

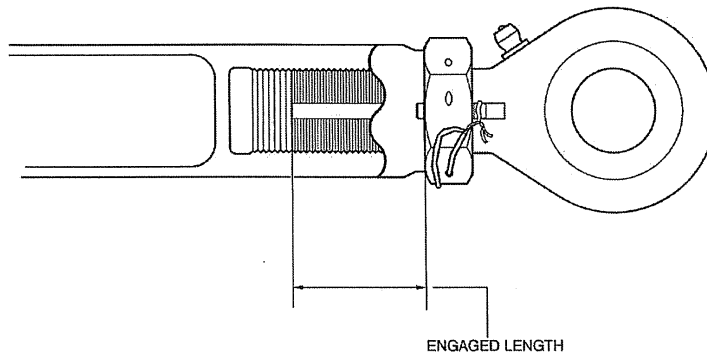
		<b>SERVICE CONCESSION REQUEST</b>			SCR NUMBER SCR 086-07	REV C	PROG 2130
		AIRCRAFT DETAILS			INDICATE IF <b>A.O.G.</b> ➤➤☒☒☒☒		
EVENT DATE (Y/M/D)	AIRLINE	A/C S/N	TSN	CSN			
ANY	ALL	4001 AND SUB					
<b>ITEM</b>	<b>PART NO.</b>	<b>NAME</b>			<b>S/N</b>	<b>TSN</b>	<b>CSN</b>
N.H.A ⇨							
N.H.A ⇨	46550-7/-9	RETRACTION ACTUATOR			ALL		
PART ⇨	46570-1/-3	PISTON			ALL		

**INSTRUCTIONS / CONTINUATION SHEET**

B) EVIDENCE OF MODERATE PITTING CORROSION CAN BE REWORKED: (REF FIG 2)

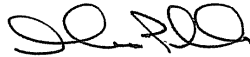
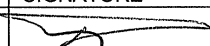
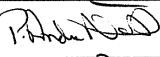
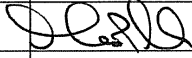
- a. TO DWG S2116 (HELICOIL SOLUTION). HELICOIL REWORK IS ACCEPTABLE FOR **1000 FC OR 6 MONTHS** (WHICH EVER OCCURS FIRST) OF CONTINUED SERVICE.
- b. TO DWG S2117 (DOWEL PIN SOLUTION) PROVIDED THAT AN ESTIMATED HALF OF THE ENGAGED THREAD VOLUME (I.E. AT LEAST THE EQUIVALENT OF 7 THREADS) REMAIN. DOWEL PIN REWORK IS ACCEPTABLE FOR **500 FC OR 3 MONTHS** (WHICH EVER OCCURS FIRST) OF CONTINUED SERVICE. **DAILY VISUAL INSPECTION** OF PIN TO ENSURE RETENTION AND ACTUATOR EXTERNAL LEAKAGE IS ALSO REQUIRED
- c. REPLACED



FOR OPTIONS a) AND b), THE RETRACT ACTUATOR IS TO BE INSPECTED TO ENSURE JAM NUT IS SECURE AND WIRE LOCK IS IN PLACE EVERY **100 FC**.



**FIGURE 2**

**DISPOSITION AUTHORIZATION**

	NAME (PRINT)	SIGNATURE	DATE(Y/M/D)	AUTHORIZED ENGINEER OR HIGHER ENGINEERING AUTHORITY   DATE: Sept 14, 2007
ENGINEERING	RAMAN MALIK		2007/09/14	
STRESS	A. NORTH		2007/09/14	
OTHER (SPECIFY)	M. PERRELLA		2007/09/14	

		<b>SERVICE CONCESSION REQUEST</b>			SCR NUMBER	REV	PROG
					SCR 086-07	C	2130
AIRCRAFT DETAILS					INDICATE IF <b>A.O.G.</b> 		
EVENT DATE (Y/M/D)	AIRLINE	A/C S/N	TSN	CSN			
ANY	ALL	4001 AND SUB					
ITEM	PART NO.	NAME			S/N	TSN	CSN
N.H.A ⇨							
N.H.A ⇨	46550-7/-9	RETRACTION ACTUATOR			ALL		
PART ⇨	46570-1/-3	PISTON			ALL		

**INSTRUCTIONS / CONTINUATION SHEET**

SUGGESTED LIST OF CIC SUPPLIERS:

CORBAN 27L      <http://www.zipchem.com/locations.aspx>

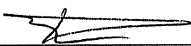
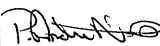

MASTINOX 6856K      <http://www.ppg.com/prc-desoto/main.asp?img=crt&contLvl=mansites>

DEFINITIONS

SURFACE CORROSION : a uniform loss of metal due to corrosion

PITTING CORROSION : a localized attack which results in a depression or a pit

**DISPOSITION AUTHORIZATION**

	NAME (PRINT)	SIGNATURE	DATE(Y/M/D)	AUTHORIZED ENGINEER OR HIGHER ENGINEERING AUTHORITY
ENGINEERING	RAMAN MALIK		2007/09/14	
STRESS	A. NORTH		2007/09/14	
OTHER (SPECIFY)	M. PERRELLA		2007/09/14	
				DATE: Sept 14, 2007





## **Bilag 31**



## Bombardier Q400

### All Operator Message No. 245

---

ATTN: Director/Manager of: Maintenance  
Engineering  
Quality Control  
Flight Operations  
Procurement/Spares

DATE: 19 SEP 07

ATA: 3200 MODEL: Q400

SUBJECT: Airworthiness Directive CF-2007-20 Reporting Requirements

REFERENCE: /A/ AOM 235, In-service Incident – Right Main Landing Gear Collapse After Landing  
/B/ AOM 236A, Update - In-service Incident – Right Main Landing Gear Collapse After Landing  
/C/ AOM 237, In-service Incident – Second Occurrence of Right Main Landing Gear Collapse After Landing  
/D/ AOM 238, Transport Canada Airworthiness Directive (AD) CF-2007-20 Issued Against DHC-8-400 Main Landing Gear  
/E/ AOM 239 RD 8/4-32-059 Revision 1 for Transport Canada AD CF-2007-20 Issued Against DHC-8-400 Main Landing Gear  
/F/ AOM 240 RD 8/4-32-059 Revision 2 for Transport Canada AD CF-2007-20 Issued Against DHC-8-400 Main Landing Gear

The following message is being sent to all Bombardier Aerospace Regional Aircraft Q400 Operators and Bombardier Aerospace Regional Aircraft Field Service Representatives.

This message contains information requiring attention and/or action. Please ensure timely and appropriate distribution within maintenance and flight operations departments.

---

#### DISCUSSION:

This AOM is being issued to provide Operators with a reporting template that will assist them in meeting the reporting requirements of Airworthiness Directive CF-2007-20 paragraph "D". "Within 7 days after each inspection, report any discrepancies found during any of the inspections to Bombardier Technical Help Desk". Using this template will ensure that Bombardier receives the information necessary to manage subsequent activities related to this Airworthiness Directive.

AM/ME

DHC8-400-AOM-245

Form No. **ISETS-03-AOM Q400** Rev. 2005-05-18 <sup>LDB</sup>

Page 1 of 2

Operators are requested to complete the attached survey or spreadsheet in detail by providing all information and selecting all applicable boxes. E mail or fax the completed survey or spreadsheet to [thd.qseries@aero.bombardier.com](mailto:thd.qseries@aero.bombardier.com) or Facsimile +1-416-375-4539. Please ensure the information is submitted for all actuators either installed, held as spare or deemed unserviceable.

Please direct responses and inquiries to your Bombardier Aerospace Regional Aircraft Field Service Representative or the Technical Help Desk in Toronto at telephone (416) 375-4000 or facsimile (416) 375-4539 or e-mail: [thd.qseries@aero.bombardier.com](mailto:thd.qseries@aero.bombardier.com).

Michel Babin, Manager, In Service Engineering Systems and Martin Elliott, Director, In-Service Engineering & Technical Support, Bombardier Regional Aircraft.

## **Bilag 32**



## Bombardier Q400

### All Operator Message No. 247

---

ATTN: Director/Manager of: Maintenance  
Engineering  
Quality Control  
Flight Operations  
Procurement/Spares

DATE: 20 Sep 07

ATA: 3210 MODEL: Q400

SUBJECT: RD 8/4-32-063 Issue 1, Repair for Corrosion Found on Retraction Actuators p/n 46550-7 or 46550-9 Cylinder and Gland Nut.

REFERENCE: /A/ AOM 238 Transport Canada Airworthiness Directive CF-2007-20 Issued Against DHC-8-400 Main Landing Gear  
/D/ Goodrich Service Concession Request SCR091-07

The following message is being sent to all Bombardier Q400 Operators and Bombardier Regional Aircraft Field Service Representatives.

This message contains information requiring attention and/or action. Please ensure timely and appropriate distribution within maintenance and flight operations departments.

---

#### DISCUSSION:

This AOM is being issued to inform Operators of the release of Repair Drawing (RD) 8/4-32-063, Issue 1. The RD and SCR are being issued to aid operators who find corrosion in this area during the General Visual Inspection (GVI) called out in section A of Airworthiness Directive (AD) No. CF-2007-20.

RD 8/4-32-063 and SCR091-07 are not mandatory, and may be accomplished at Operators discretion.

Please direct responses and inquiries to your Bombardier Regional Aircraft Field Service Representative or the Technical Help Desk in Toronto at telephone (416) 375-4000 or facsimile (416) 375-4539 or e-mail: [thd.qseries@aero.bombardier.com](mailto:thd.qseries@aero.bombardier.com)

Alisa Turk, Manager, Technical Help Desk and Martin Elliott, Director, In-Service Engineering & Technical Support, Bombardier Regional Aircraft.





## **Bilag 32A**



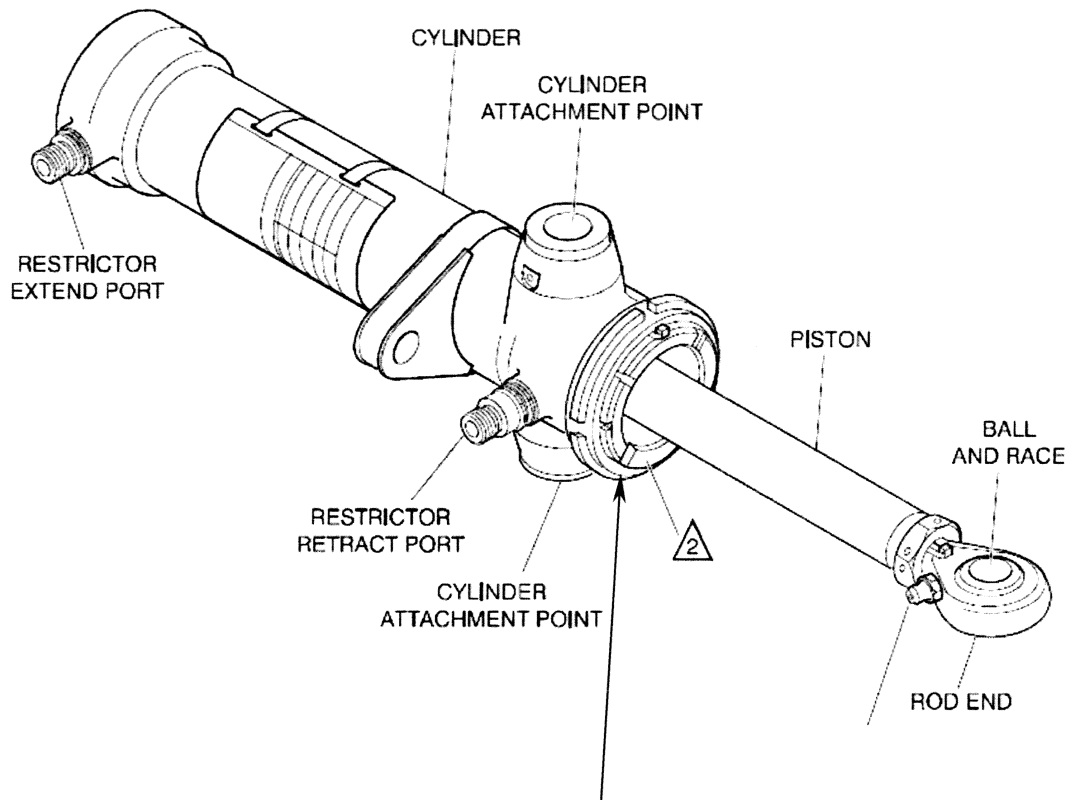
# BOMBARDIER

## REPAIR DRAWING (RD)

1 TITLE <b>Inspection procedure for retraction actuators p/n 46550-7 or 46550-9 Cylinder and Gland Nut.</b>		2 RD NUMBER <b>8/4-32-063</b>	
		3 SECTION <b>1</b>	4 SHEET <b>1</b>
5 PRIME DESIGN ACTIVITY <b>BOMBARDIER INC., DOWNSVIEW 71867</b>	6 ADDITIONAL LIMITATIONS <b>NONE</b>	7 SERIES <b>DHC-8-400</b>	8 APPLICABILITY <b>Series 400 Models 400, 401 and 402</b>
9 DESCRIPTION			
<p>This RD defines an inspection procedure for retraction actuators p/n 46550-7 or 46550-9 cylinder and gland nut.</p> <p>This RD is to be accomplished in conjunction with Goodrich SCR 091-07 rev. NC.</p> <p>The procedure involves removing the actuator cylinder gland nut of the retraction actuator assembly in accordance with SCR 091-07 rev. NC and inspecting affected parts for any signs of corrosion or wear.</p> <p><b>Provided the components are free of any damage except as permitted by SCR 091-07 rev NC.</b></p> <p><b>Re-assemble retraction actuator in accordance with SCR 091-07 rev. NC.</b></p> <p>The details of this procedure are covered by RD 8/4-32-063 section 1.</p> <p style="text-align: right;">Sheet 1 Issue 1 Sheet 2 Issue 1</p>			
10 ISSUE	<b>1</b>		
11 DATE	<b>20-Sep-07</b>		
12 PREPARED BY	<b>D. De Vogel</b>		
13 STRESS	<i>E. Smith</i>		
16 DESIGN AUTHORITY	<i>M. BASIN</i>		
14			
15			
17 DAO AUTHORITY	<i>Sp. J. Valles #233 As per RD #233 20-Sep-2007</i>		
18	<input checked="" type="checkbox"/> THE TECHNICAL CONTENT OF THIS DOCUMENT IS APPROVED UNDER THE DESIGN AUTHORITY OF TRANSPORT CANADA DESIGN APPROVAL ORGANIZATION DAO NO. 93-Q-02		<input type="checkbox"/> BA ENGINEERING DISPOSITION FOR APPROVAL BY OPERATOR'S LOCAL AIRWORTHINESS AUTHORITY
<small>THIS REPAIR DRAWING HAS BEEN PREPARED ON THE BASIS OF INFORMATION SUPPLIED TO BOMBARDIER INC. BY THE OPERATOR OR HIS AGENT. IT IS THE RESPONSIBILITY OF THE OPERATOR OR HIS AGENT TO VERIFY THAT THE INFORMATION SUPPLIED IS COMPLETE AND ACCURATE. BOMBARDIER INC. DOES NOT ACCEPT RESPONSIBILITY FOR ANY CONSEQUENCE RESULTING FROM INCOMPLETE OR INACCURATE REPORTING OF THE DAMAGE / DISCREPANCY.</small>			
<small>THE INFORMATION, TECHNICAL DATA AND DESIGNS DISCLOSED HEREIN ARE THE EXCLUSIVE PROPERTY OF BOMBARDIER INC. OR CONTAIN PROPRIETARY RIGHTS OF OTHERS AND ARE NOT TO BE USED OR DISCLOSED TO OTHERS WITHOUT THE WRITTEN CONSENT OF BOMBARDIER INC. THE RECIPIENT OF THIS DOCUMENT, BY ITS RETENTION AND USE AGREES TO HOLD IN CONFIDENCE THE TECHNICAL DATA AND DESIGNS CONTAINED HEREIN. THE FOREGOING SHALL NOT APPLY TO PERSONS HAVING PROPRIETARY RIGHTS TO SUCH INFORMATION, TECHNICAL DATA OR SUCH DESIGNS TO THE EXTENT THAT SUCH RIGHTS EXIST.</small>			

10 ISSUE	1				2 RD NUMBER	3 SECTION	4 SHEET
					8/4-32-059	1	2

## Retraction actuator assembly p/n 46550-7/-9



Remove the rod end of the retraction actuator assembly in accordance with SCR 091-07 rev. NC


Inspect cylinder P/N 4655-1 for evidence of corrosion on Gland Nut threads.

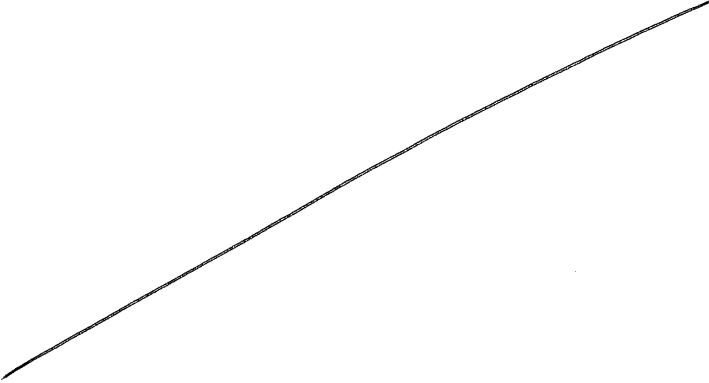
Inspect Gland Nut P/N 46572-5 for evidence of corrosion on threads.

Provided the components are free of any damage/corrosion, re-assemble retraction actuator in accordance with SCR 091-07 rev. NC

## **Bilag 32B**




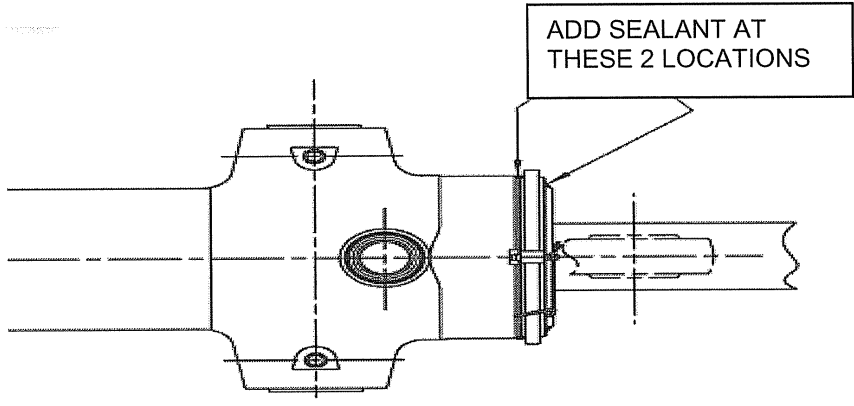
		<b>SERVICE CONCESSION REQUEST</b>			SCR NUMBER SCR091-07	REV NC	PROG 2130
		AIRCRAFT DETAILS			INDICATE IF <b>A.O.G.</b> ➤ ➤ <input type="checkbox"/> ⬅ ⬅		
EVENT DATE (Y/M/D)	AIRLINE	A/C S/N	TSN	CSN			
2007/09/18	ALL	DASH 8Q400	NA	NA			
<b>ITEM</b>	<b>PART NO.</b>	<b>NAME</b>			<b>S/N</b>	<b>TSN</b>	<b>CSN</b>
N.H.A ➔							
N.H.A ➔	46550-7/-9	MLG RETRACTION ACTUATOR			NA	NA	NA
PART ➔	46551-1 46572-3/-5	CYLINDER GLAND NUT			ALL	NA	NA
<b>LIMITED FLIGHT REQUESTED</b> YES <input type="checkbox"/> NO <input checked="" type="checkbox"/> (IF YES, AUTHORIZED ENGINEER SIGNATURE REQUIRED)		REQUEST CATEGORY			AFFECTED SYSTEM		
		IN-SERVICE PROBLEM <input checked="" type="checkbox"/>			MLG <input checked="" type="checkbox"/>	BRAKING <input type="checkbox"/>	
INDICATE FC OR FH LIMITATION:		<b>DISPOSITION SUMMARY</b> NORMAL USE AFTER REPAIR <input checked="" type="checkbox"/> LIMITED SERVICE <input type="checkbox"/> TEMPORARY REPAIR <input type="checkbox"/> REMOVE & REPAIR <input type="checkbox"/> REPLACE PART <input type="checkbox"/>			<b>PREVIOUS CONCESSIONS GRANTED FOR THIS SERIAL NUMBER COMPONENT</b> SCR086-07		
FC* _____ FH* _____ *WHICH EVER COMES FIRST							
IF ONLY FC IS SPECIFIED INDICATE FH NOT RELEVANT <input type="checkbox"/>							
OR SPECIFY LIMITATION IN TERMS OF AIRCRAFT CHECKS: A <input type="checkbox"/> C <input type="checkbox"/> L <input type="checkbox"/> x							
SCR RAISED BY						DATE RAISED	
B. HAYHURST						2007/09/18	

ITEM	PROBLEM DESCRIPTION
1.	CYLINDER PN 46551-1 HAS EVIDENCE OF CORROSION ON GLAND NUT THREADS.
2.	GLAND NUT P/N 46572-5 HAS EVIDENCE OF CORROSION ON THREADS.
	
REPORTED CAUSE OF PROBLEM:	
ADDITIONAL INFORMATION ATTACHED <input type="checkbox"/>	
➤ ➤ SEE SHEET 2 AND SUBS FOR MORE INFORMATION ⬅ ⬅	

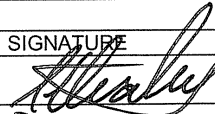
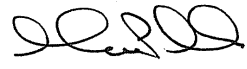
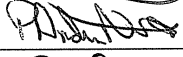
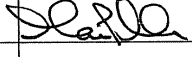





		<b>SERVICE CONCESSION REQUEST</b>			SCR NUMBER SCR091-07	REV NC	PROG 2130
		AIRCRAFT DETAILS			INDICATE IF <b>A.O.G.</b> ➤➤ <input type="checkbox"/> ⬅️⬅️		
EVENT DATE (Y/M/D)	AIRLINE	A/C S/N	TSN	CSN			
2007/09/18	ALL	DASH 8Q400	NA	NA			
<b>ITEM</b>	<b>PART NO.</b>	<b>NAME</b>			<b>S/N</b>	<b>TSN</b>	<b>CSN</b>
N.H.A ⇨							
N.H.A ⇨	46550-7/-9	MLG RETRACTION ACTUATOR			NA	NA	NA
PART ⇨	46551-1 46572-3/-5	CYLINDER GLAND NUT			ALL	NA	NA

ITEM	CONTINUATION SHEET / INSTRUCTIONS
1. 2.	<p><b>ACTUATOR DISASSEMBLY AND REASSEMBLY</b></p> <ol style="list-style-type: none"> <li>1. DISASSEMBLE AS REQUIRED TO REMOVE PISTON AND GLAND NUT FROM CYLINDER ASSEMBLY IN ACCORDANCE WITH CMM 32-31-06 REQUIREMENTS.</li> <li>2. REMOVE ALL SEALS FROM GLAND NUT AND PISTON HEAD AND DISCARD.</li> <li>3. PERFORM INSPECTION AND REWORK OF ACTUATOR CYLINDER P/N 46551-1 IN ACCORDANCE WITH <b>PART 1</b> OF THIS SCR.</li> <li>4. PERFORM INSPECTION AND REWORK OF GLAND NUT P/N 46572-5 IN ACCORDANCE WITH <b>PART 2</b> OF THIS SCR.</li> <li>5. PRIOR TO REASSEMBLY OF UNIT COAT CYLINDER P/N 46551-1 THREADS AND GLAND NUT P/N 46572-5 THREADS WITH A LIBERAL COATING OF MASTINOX 6856K <b>ONLY</b>.</li> <li>6. REASSEMBLE UNIT IN ACCORDANCE WITH CMM 32-31-06 REQUIREMENTS</li> <li>7. INSPECT – CHECK GLAND NUT FOR EVIDENCE OF BACKLASH ONCE JAM NUT IS INSTALLED AND FULLY TORQUED.             <ul style="list-style-type: none"> <li>– NO BACKLASH IS ALLOWED</li> <li>– IF BACKLASH FOUND CONTACT GOODRICH FOR FURTHER INSTRUCTIONS</li> </ul> </li> <li>8. PERFORM COMPLETE ACCEPTANCE TEST PER CMM 32-31-06 REQUIREMENTS</li> <li>9. NOTE: IT IS ACCEPTABLE TO USE TOOL CG 56806 TO SET THE RETRACTED STROKE LENGTH IN LIEU OF CMM SPECIFIED TOOLING.</li> <li>10. APPLY A BEAD OF AMS 8802 OR MIL-PRF-81733 SEALANT TO JAM NUT/GLAND NUT INTERFACE AS WELL AS JAM NUT/CYLINDER INTERFACE, ENSURING THAT ALL KEYWAY SLOTS ARE FILLED (REF. FIGURE 1)</li> <li>11. COMPLETE UNIT IN ACCORDANCE WITH CMM 32-31-06 REQUIREMENTS.</li> </ol>
	

**FIGURE 1**

<b>DISPOSITION AUTHORIZATION</b>				
	NAME (PRINT)	SIGNATURE	DATE(Y/M/D)	AUTHORIZED ENGINEER OR HIGHER ENGINEERING AUTHORITY
ENGINEER	S.HEALEY		2007/09/20	 DATE: <b>Sept 20, 2007</b>
STRESS	A.NORTH		2007/09/20	
OTHER (SPECIFY)	M.PERRELLA		2007/09/20	
				<b>Page 2 of 7</b>




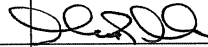
		<b>SERVICE CONCESSION REQUEST</b>			SCR NUMBER SCR091-07	REV NC	PROG 2130
		AIRCRAFT DETAILS			INDICATE IF <b>A.O.G.</b> ➤ ➤ <input type="checkbox"/> ⏪ ⏩		
EVENT DATE (Y/M/D)	AIRLINE	A/C S/N	TSN	CSN			
2007/09/18	ALL	DASH 8Q400	NA	NA			
<b>ITEM</b>	<b>PART NO.</b>	<b>NAME</b>			<b>S/N</b>	<b>TSN</b>	<b>CSN</b>
N.H.A ⇨							
N.H.A ⇨	46550-7/-9	MLG RETRACTION ACTUATOR			NA	NA	NA
PART ⇨	46551-1 46572-3/-5	CYLINDER GLAND NUT			ALL	NA	NA


**INSTRUCTIONS / CONTINUATION SHEET**

**PART 1 – FOR CYLINDERS WITH EVIDENCE OF CORROSION IN GLAND NUT THREADS**

1. CLEAN THREADS USING A STAINLESS STEEL WIRE BRUSH AND SOLVENT, TO REMOVE ALL F.O.D AND CORROSION BY PRODUCTS
2. VISUALLY INSPECT THREADS AND THREAD RELIEF AREA FOR EVIDENCE OF PITTING AND DAMAGE TO THE THREAD FORM USING 10 X MAGNIFICATION
3. IF THREADS ARE FOUND WITH **LIGHT SURFACE CORROSION ONLY** (I.E. NO PITTING OR THREAD FORM DAMAGE) PROCEED WITH OPERATIONS 5 THRU 10 UNDER PART 1 OF THIS SCR
4. IF THREADS ARE FOUND TO HAVE PITTING OR DAMAGE TO THE THREAD FORM THEN CONTINUE WITH **SECTION A** OF THIS SCR.
5. LIGHTLY CHASE THREADS USING A WIRE BRUSH OR THREAD COMB AS REQUIRED TO REMOVE ALL EVIDENCE OF CORROSION.
6. LIGHTLY POLISH THREAD RELIEF AREA AND ADJACENT CHAMFER AS/IF REQUIRED TO REMOVE ALL EVIDENCE OF CORROSION.
7. INSPECT – ENSURE ALL EVDIENCE OF CORROSION HAS BEEN REMOVED (NO PITTING) AND THAT THREAD FORM REMAINS UNDAMAGED, USING 10 X MAGNIFICATION.
8. SOLVENT CLEAN REWORKED AREAS PER CMM 32-31-06 REQUIREMENTS
9. TOUCH UP BRUSH CAD PLATE REWORKED AREAS PER CMM 32-31-06 REQUIREMENTS (REF. FIGURE 2).
10. COMPLETE PART PER CMM 32-31-06 REQUIREMENTS, AND RETURN TO PAGE 2 OF THIS SCR AND COMPLETE REASSEMBLY PER OPERATIONS 5 THRU 10.

**DISPOSITION AUTHORIZATION**

	NAME (PRINT)	SIGNATURE	DATE(Y/M/D)	AUTHORIZED ENGINEER OR HIGHER ENGINEERING AUTHORITY
ENGINEERING	S.HEALEY		2007/09/20	 DATE: Sept 20, 2007
STRESS	A.NORTH		2007/09/20	
OTHER (SPECIFY)	M.PERRELLA		2007/09/20	
				<b>Page 3 of 7</b>

		<b>SERVICE CONCESSION REQUEST</b>			SCR NUMBER SCR091-07	REV NC	PROG 2130
		AIRCRAFT DETAILS			INDICATE IF <b>A.O.G.</b> ➤ <input type="checkbox"/> ◀		
EVENT DATE (Y/M/D)	AIRLINE	A/C S/N	TSN	CSN			
2007/09/18	ALL	DASH 8Q400	NA	NA			
<b>ITEM</b>	<b>PART NO.</b>	<b>NAME</b>			<b>S/N</b>	<b>TSN</b>	<b>CSN</b>
N.H.A ⇒							
N.H.A ⇒	46550-7/-9	MLG RETRACTION ACTUATOR			NA	NA	NA
PART ⇒	46551-1 46572-3/-5	CYLINDER GLAND NUT			ALL	NA	NA

**INSTRUCTIONS / CONTINUATION SHEET**

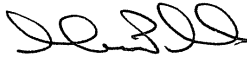


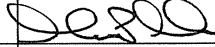
**SECTION A – CYLINDERS REQUIRING REWORK TO THREADS**


1. MASK AS REQUIRED TO PROTECT CYLINDER INSIDE DIAMETER, AND EXTERIOR FROM F.O.D CONTAMINATION OR DAMAGE DURING THE FOLLOWING REWORK STEPS.
    2. CHASE DISCREPANT THREADS USING A THREAD COMB OR EQUIVALENT TO REMOVE ALL EVIDENCE OF CORROSION FROM THREAD FORM.
    3. DEBURR/BLEND AS/IF REQUIRED TO REMOVE ALL EVIDENCE OF PITTING AND/OR DAMAGE FROM THREADS AND THREAD RELIEF AREAS
    4. INSPECT – USING 10 X MAGNIFICATION ENSURE ALL EVIDENCE OF PITTING AND/OR DAMAGE HAS BEEN REMOVED.
      - IF EVIDENCE OF PITTING OR DAMAGE STILL REMAINS THEN PERFORM OPTIONAL REWORKS A OR B TO COMPLETELY REMOVE DAMAGE.
      - IF ALL EVIDENCE OF PITTING AND/OR DAMAGE HAS BEEN REMOVED ENSURE THREADS AND THREAD RELIEF AREA CONFORM TO THE FOLLOWING;
 

**ACCEPTANCE CRITERIA**

        - I) AN OVERSIZE CONDITION OF NO MORE THAN .002 INCH ON MAJOR, MINOR AND PITCH DIAMETERS IS PERMISSIBLE.
        - II) AREAS OF MISSING THREADS MAY ACCOUNT FOR NO MORE THAN 10% OF THE TOTAL THREADED AREA.
        - III) BLENDED DEPRESSIONS IN THREAD RELIEF AREA MAY NOT EXCEED .005 INCH IN DEPTH.
- IF CRITERIA I) AND/OR II) ARE NOT SATISFIED THEN CONTINUE WITH OPTIONAL REWORKS A OR B.
5. MAGNETIC PARTICLE INSPECT REWORKED AREAS PER ASTM E-1417. DEFECTS NOT TO EXCEED MIL-STD-1907, GRADE 'A' LIMITS
  6. MASK AS REQUIRED TO PROTECT THREADS AND LOCALLY SHOT PEEN REWORKED THREAD RELIEF AREAS PER MIL-R-81841, USING HARD SHOT (HRC 55-65), SHOT SIZE 170-280, INTENSITY .010-.014A, COVERAGE 200%.
  7. SOLVENT CLEAN REWORKED AREAS PER CMM 32-31-06 REQUIREMENTS
  8. BRUSH CAD PLATE REWORKED AREAS PER MIL-STD-867 AND CMM REQUIREMENTS, USING LHE SOLUTION (REF. FIGURE 2)
  9. RETURN TO SHEET 2 OF THIS SCR, AND COMPLETE REASSEMBLY PER OPERATIONS 5 THRU 10.

**DISPOSITION AUTHORIZATION**

	NAME (PRINT)	SIGNATURE	DATE(Y/M/D)	AUTHORIZED ENGINEER OR HIGHER ENGINEERING AUTHORITY   DATE: Sept 20, 2007
ENGINEERING	S.HEALEY		2007/09/20	
STRESS	A.NORTH		2007/09/20	
OTHER (SPECIFY)	M.PERRELLA		2007/09/20	

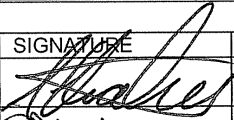
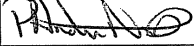

		<b>SERVICE CONCESSION REQUEST</b>			SCR NUMBER SCR091-07	REV NC	PROG 2130
		AIRCRAFT DETAILS			INDICATE IF <b>A.O.G.</b> ➤ <input type="checkbox"/> ◀		
EVENT DATE (Y/M/D)	AIRLINE	A/C S/N	TSN	CSN			
2007/09/18	ALL	DASH 8Q400	NA	NA			
ITEM	PART NO.	NAME		S/N	TSN	CSN	
N.H.A ⇨							
N.H.A ⇨	46550-7/-9	MLG RETRACTION ACTUATOR		NA	NA	NA	
PART ⇨	46551-1 46572-3/-5	CYLINDER GLAND NUT		ALL	NA	NA	


**INSTRUCTIONS / CONTINUATION SHEET**

**OPTIONAL REWORK A**

1.
  1. DISASSEMBLE PART AS REQUIRED TO REMOVE ALL BUSHINGS AND RESTRICTOR FITTINGS PER CMM 32-31-06 REQUIREMENTS
  2. REMOVE PAINT AND PRIMER PER CMM 32-31-06 REQUIREMENTS
  3. STRIP CADMIUM PLATING FROM ALL OVER PARTS
  4. SET UP PART ON MACHINE AND USING SINGLE POINT TOOLING, CHASE THREADS TO REMOVE .010 INCH FROM ALL OVER THREAD FORM AND THREAD RELIEF AREA, USING MINIMUM FEEDS AND SPEEDS.
  5. SOLVENT CLEAN REWORKED AREAS PER CMM 32-31-06 REQUIREMENTS
  6. INSPECT – ENSURE ALL EVIDENCE OF CORROSION AND THREAD DAMAGE HAS BEEN REMOVED USING 10 X MAGNIFICATION
    - ENSURE REWORKED THREADS CONFORM TO THE FOLLOWING REQUIREMENTS;
      - i. THREAD MAJOR DIA 3.0200, MINOR DIA 2.9389/2.9489, PITCH DIA 2.9659/2.9721
      - ii. AREAS OF MISSING THREADS MAY ACCOUNT FOR NO MORE THAN 10% OF THE TOTAL THREADED AREA.
  7. BRUSH ETCH INSPECT REWORKED AREAS PER MIL-STD-867
  8. MAGNETIC PARTICLE INSPECT REWORKED AREAS PER ASTM E-1417. DEFECTS NOT TO EXCEED MIL-STD-1907, GRADE 'A' LIMITS
  9. MASK AS REQUIRED TO PROTECT THREADS AND LOCALLY SHOT PEEN THREAD RELIEF PER MIL-R-81841, USING HARD SHOT (HRC 55-65), SHOT SIZE 170-280, INTENSITY .010-.014A, COVERAGE 200%.
  10. MASK AS REQD AND ELECTROLESS NICKEL PLATE REWORKED AREAS (THREAD AND THREAD RELIEF ONLY) PER AMS 2404, TO A THICKNESS OF .002 TO .0025 INCH.
  11. BAKE PART AT 375+/-25 DEG F FOR 23 HRS.
  12. INSPECT – ENSURE FULL COVERAGE OF THREADS INCLUDING THREAD ROOTS, AND NO EVIDENCE OF PITTING IN NICKEL PLATED AREA
  13. MASK AS REQD AND CADMIUM PLATE PART PER CMM 32-31-06 REQUIREMENTS
  14. BAKE PART AT 375+/-25 DEG F FOR 8 HRS
  15. MAGNETIC PARTICLE INSPECT REWORKED AREAS PER ASTM E-1417. DEFECTS NOT TO EXCEED MIL-STD-1907, GRADE 'A' LIMITS
  16. MASK AS REQD AND APPLY PRIMER IN ACCORDANCE WITH CMM REQUIREMENTS.
  17. MASK AS REQUIRED AND INSTALL BUSHINGS PER CMM 32-31-06 REQUIREMENTS
  18. MASK AS REQD AND APPLY TOP COAT IN ACCORDANCE WITH CMM 32-31-06 REQUIREMENTS
  19. REASSEMBLE PART WITH RESTRICTOR FITTINGS PER CMM 32-31-06 REQUIREMENTS
  20. RETURN TO SCR PAGE 2, AND COMPLETE REASSEMBLY PER OPERATIONS 5 THRU 10.

**DISPOSITION AUTHORIZATION**

ENGINEERING	NAME (PRINT)	SIGNATURE	DATE(Y/M/D)	AUTHORIZED ENGINEER OR HIGHER ENGINEERING AUTHORITY  DATE: <b>Sept 20, 2007</b>
	S.HEALEY		2007/09/20	
	A.NORTH		2007/09/20	
	M.PERRELLA		2007/09/20	

		<b>SERVICE CONCESSION REQUEST</b>			SCR NUMBER SCR091-07	REV NC	PROG 2130
		AIRCRAFT DETAILS			INDICATE IF <b>A.O.G.</b> ➤ ➤ <input type="checkbox"/> ⬅ ⬅		
EVENT DATE (Y/M/D)	AIRLINE	A/C S/N	TSN	CSN			
2007/09/18	ALL	DASH 8Q400	NA	NA			
<b>ITEM</b>	<b>PART NO.</b>	<b>NAME</b>			<b>S/N</b>	<b>TSN</b>	<b>CSN</b>
N.H.A ⇨							
N.H.A ⇨	46550-7/-9	MLG RETRACTION ACTUATOR			NA	NA	NA
PART ⇨	46551-1 46572-3/-5	CYLINDER GLAND NUT			ALL	NA	NA

**INSTRUCTIONS / CONTINUATION SHEET**

**OPTIONAL REWORK B**

1. CREATE 1/16 O/S CYLINDER THREADS AND SPECIAL GLAND NUT IN ACCORDANCE WITH DRAWING S211X
2. RETURN TO PAGE 2 OF THIS SCR AND COMPLETE REASSEMBLY PER OPERATIONS 5 THRU 10.

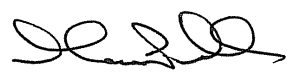
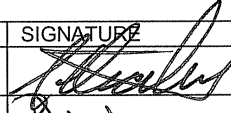
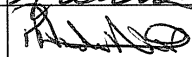
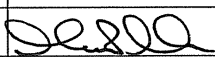
**PART 2 – GLAND NUTS REQUIRING REWORK TO THREADS**


2.
  1. CHASE DISCREPANT THREADS USING A THREAD COMB OR EQUIVALENT TO REMOVE ALL EVIDENCE OF CORROSION FROM THREAD FORM.
  2. DEBURR/BLEND AS/IF REQUIRED TO REMOVE ALL EVDIENCE OF PITTING AND/OR DAMAGE FROM THREADS AND THREAD RELIEF AREAS
  3. SOLVENT CLEAN REWORKED AREAS PER CMM 32-31-06 REQUIREMENTS
  4. INSPECT – USING 10 X MAGNIFICATION ENSURE ALL EVIDENCE OF PITTING AND/OR DAMAGE HAS BEEN REMOVED.
    - IF ALL EVIDENCE OF PITTING AND/OR DAMAGE HAS BEEN REMOVED ENSURE THREADS AND THREAD RELIEF AREA CONFORM TO THE FOLLOWING;
 

**ACCEPTANCE CRITERIA**

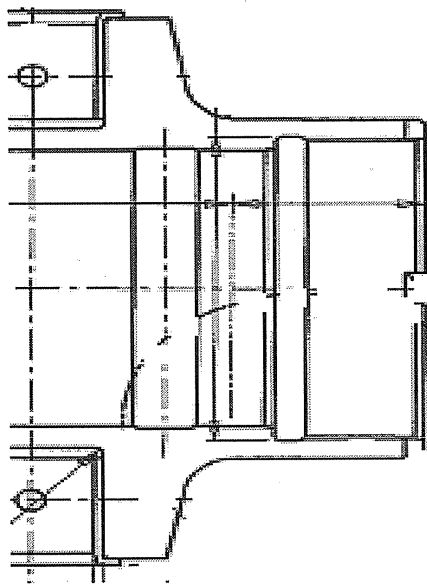
      - I) AN UNDERSIZE CONDITION OF NO MORE THAN .002 INCH ON MAJOR, MINOR AND PITCH DIAMETERS, IS PERMISSIBLE
      - II) AREAS OF MISSING THREADS MAY ACCOUNT FOR NO MORE THAN 10% OF THE TOTAL THREADED AREA.
      - III) IF THE ABOVE CRITERIA ARE NOT SATISFIED THEN DISCARD GLAND NUT.
  5. LIQUID PENETRANT INSPECT REWORKED AREAS PER ASTM E-1417, TYPE I, SENSITIVITY LEVEL 3. DEFECTS NOT TO EXCEED MIL-STD-1907, GRADE 'A' LIMITS.
  6. SOLVENT CLEAN REWORKED AREAS PER CMM 32-31-06 REQUIREMENTS
  7. BRUSH ALODINE REWORKED AREAS PER MIL-C-5541, TYPE I, AND CMM 32-31-06 REQUIREMENTS
  8. COMPLETE PART PER CMM 32-31-06 REQUIREMENTS, AND RETURN TO PAGE 2 OF THIS SCR AND COMPLETE REASSEMBLY PER OPERATIONS 5 THRU 10.

**DISPOSITION AUTHORIZATION**

	NAME (PRINT)	SIGNATURE	DATE(Y/M/D)	AUTHORIZED ENGINEER OR HIGHER ENGINEERING AUTHORITY   DATE: Sept 20, 2007
ENGINEERING	S.HEALEY		2007/09/20	
STRESS	A.NORTH		2007/09/20	
OTHER (SPECIFY)	M.PERRELLA		2007/09/20	
				<b>Page 6 of 7</b>

		<b>SERVICE CONCESSION REQUEST</b>			SCR NUMBER	REV	PROG
					SCR091-07	NC	2130
AIRCRAFT DETAILS					INDICATE IF <b>A.O.G.</b> >> <input type="checkbox"/> <<		
EVENT DATE (Y/M/D)	AIRLINE	A/C S/N	TSN	CSN			
2007/09/18	ALL	DASH 8Q400	NA	NA			
ITEM	PART NO.	NAME			S/N	TSN	CSN
N.H.A ⇨							
N.H.A ⇨	46550-7/-9	MLG RETRACTION ACTUATOR			NA	NA	NA
PART ⇨	46551-1 46572-3/-5	CYLINDER GLAND NUT			ALL	NA	NA



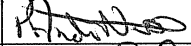
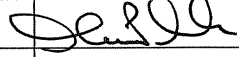
INSTRUCTIONS / CONTINUATION SHEET



1.34

APPLY BRUSH CAD  
PLATING OVER THIS  
LENGTH FULL  
CIRCUMFERENCE

**FIGURE 2**

DISPOSITION AUTHORIZATION				AUTHORIZED ENGINEER OR HIGHER ENGINEERING AUTHORITY
	NAME (PRINT)	SIGNATURE	DATE(Y/M/D)	
ENGINEERING	S.HEALEY		2007/09/20	 DATE: Sept 20, 2007
STRESS	A.NORTH		2007/09/20	
OTHER (SPECIFY)	M.PERRELLA		2007/09/20	
				<b>Page 7 of 7</b>

## **Bilag 33**





## Bombardier Q400

### All Operator Message No. 250

---

---

ATTN: Director/Manager of: Maintenance  
Engineering  
Quality Control  
Flight Operations  
Procurement/Spares

DATE: 01 OCT 07

ATA: 3210 MODEL: Q400

SUBJECT: RD 8/4-32-059 Issue 5 for Transport Canada AD CF-2007-20 Issued Against  
DHC-8-400 Main Landing Gear

REFERENCE: /A/ Transport Canada AD CF-2007-20 Issued Against DHC-8-400 Main  
Landing Gear  
/B/ AOM 243 RD 8/4-32-059 Issue 4 for Transport Canada AD CF-2007-20  
Issued Against DHC-8-400 Main Landing Gear  
/C/ RD 8/4-32-059 Issue 5 for Inspection Procedure for actuators p/n 46550-7  
or 46550-9 rod end  
/D/ Goodrich Service Concession Request SCR086-07 Rev D Retraction  
Actuator Rework

The following message is being sent to all Bombardier Q400 Operators and Bombardier Regional Aircraft Field Service Representatives.

This message contains information requiring attention and/or action. Please ensure timely and appropriate distribution within maintenance and flight operations departments.

---

---

#### DISCUSSION:

This AOM is being issued to inform Operators of the release of Repair Drawing (RD) 8/4-32-059 Issue 5 required for compliance to Transport Canada Airworthiness Directive (AD) No. CF-2007-20. Issue 5 of (RD) 8/4-32-059 is being revised to clarify the initial visual inspection done without using the 10 X magnification, add repeat inspection criteria and remove the dowel pin rework.

Operators having complied with Issue 1 of RD 8/4-32-059 with no findings are not required to repeat the inspections specified in Issue 2, 3 or 4. However prior to reaching 500 FC, inspection of the threads is required using 10X magnification following instructions in RD 8/4-32-059 issue 5.

Please direct responses and inquiries to your Bombardier Regional Aircraft Field Service Representative or the Technical Help Desk in Toronto at telephone (416) 375-4000 or facsimile (416) 375-4539 or e-mail: [thd.qseries@aero.bombardier.com](mailto:thd.qseries@aero.bombardier.com)

Alisa Turk, Manager, Technical Help Desk and Martin Elliott, Director, In-Service Engineering & Technical Support, Bombardier Regional Aircraft.

## **Bilag 33A**



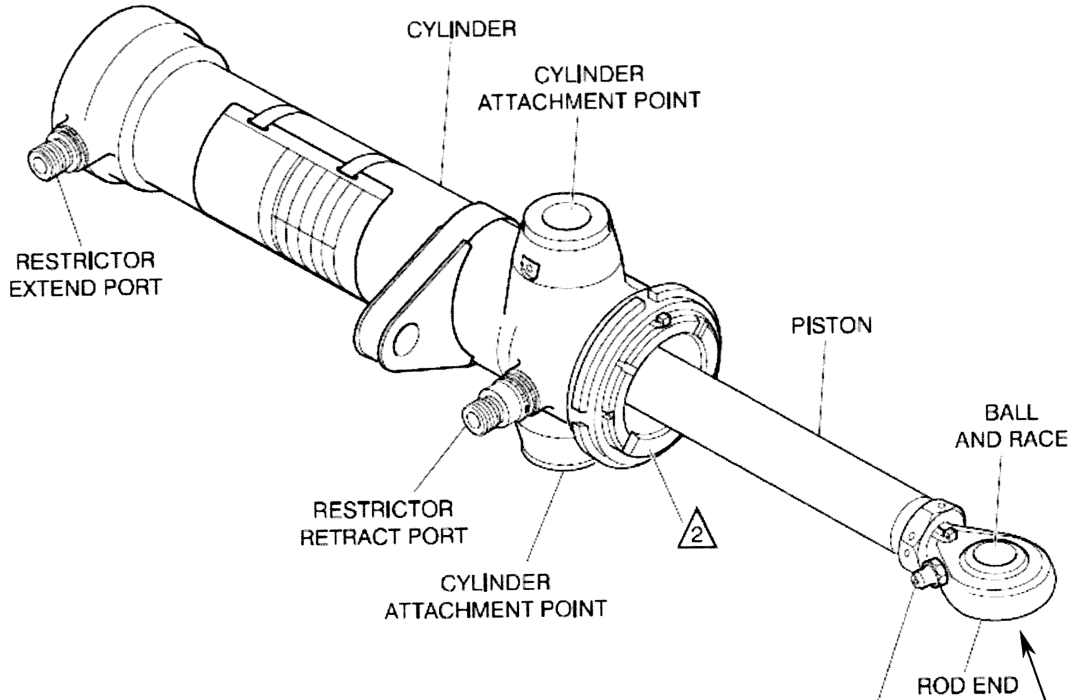
# BOMBARDIER

## REPAIR DRAWING (RD)

1 TITLE <b>Inspection procedure for retraction actuators p/n 46550-7 or 46550-9 rod end.</b>			2 RD NUMBER <b>8/4-32-059</b>		
			3 SECTION <b>1</b>	4 SHEET <b>1</b>	
5 PRIME DESIGN ACTIVITY <b>BOMBARDIER INC., DOWNSVIEW 71867</b>	6 ADDITIONAL LIMITATIONS <b>NONE</b>	7 SERIES <b>DHC-8-400</b>	8 APPLICABILITY <b>Models 400, 401 and 402</b>		
9 DESCRIPTION  <p><b><u>This page re-written at Issue #5.</u></b>-SCR086-07 raised to Rev. D</p> <p>This RD defines an inspection procedure for retraction actuators p/n 46550-7 or 46550-9 rod end.</p> <p>This RD is to be accomplished in conjunction with Goodrich SCR 086-07 rev. D.</p> <p>The procedure involves removing the rod end of the retraction actuator assembly in accordance with SCR 086-07 rev. D and inspecting affected parts for any signs of corrosion or wear.</p> <p><b>Provided the components are free of any damage re-assemble retraction actuator in accordance with SCR 086-07 rev. D.</b></p> <p>The details of this procedure are covered by RD 8/4-32-059 section 1.</p> <p style="text-align: right;">Sheet 1 Issue 5 Sheet 2 Issue 5</p> <p><b>At SCR 086-07 Rev D: Rework for Freeze fit Pin in SCR now deleted-Ref. Dwg S2117-deleted. New Inspection criteria added for reworked Actuators (excluding those repaired by Section B) Page 1,2 raised to Issue # 5.</b></p>					
10 ISSUE	<b>5</b>				
11 DATE	<b>20-Sep-07</b>				
12 PREPARED BY	<b>D. Devogel</b>				
13 STRESS	<i>[Signature]</i>				
16 DESIGN AUTHORITY	<i>[Signature]</i> #233 20 SEP 2007				
14					
15 DAO AUTHORITY	<i>[Signature]</i> #233 20 SEP 2007				
17 DAO AUTHORITY	<i>[Signature]</i> #233 20 SEP 2007				
18	<input checked="" type="checkbox"/> THE TECHNICAL CONTENT OF THIS DOCUMENT IS APPROVED UNDER THE DESIGN AUTHORITY OF TRANSPORT CANADA DESIGN APPROVAL ORGANIZATION DAO NO. 93-Q-02			<input type="checkbox"/> BA ENGINEERING DISPOSITION FOR APPROVAL BY OPERATOR'S LOCAL AIRWORTHINESS AUTHORITY	
THIS REPAIR DRAWING HAS BEEN PREPARED ON THE BASIS OF INFORMATION SUPPLIED TO BOMBARDIER INC. BY THE OPERATOR OR HIS AGENT. IT IS THE RESPONSIBILITY OF THE OPERATOR OR HIS AGENT TO VERIFY THAT THE INFORMATION SUPPLIED IS COMPLETE AND ACCURATE. BOMBARDIER INC. DOES NOT ACCEPT RESPONSIBILITY FOR ANY CONSEQUENCE RESULTING FROM INCOMPLETE OR INACCURATE REPORTING OF THE DAMAGE/DISCREPANCY.			THE INFORMATION, TECHNICAL DATA AND DESIGNS DISCLOSED HEREIN ARE THE EXCLUSIVE PROPERTY OF BOMBARDIER INC. OR CONTAIN PROPRIETARY RIGHTS OF OTHERS AND ARE NOT TO BE USED OR DISCLOSED TO OTHERS WITHOUT THE WRITTEN CONSENT OF BOMBARDIER INC. THE RECIPIENT OF THIS DOCUMENT, BY ITS RETENTION AND USE AGREES TO HOLD IN CONFIDENCE THE TECHNICAL DATA AND DESIGNS CONTAINED HEREIN. THE FOREGOING SHALL NOT APPLY TO PERSONS HAVING PROPRIETARY RIGHTS TO SUCH INFORMATION, TECHNICAL DATA OR SUCH DESIGNS TO THE EXTENT THAT SUCH RIGHTS EXIST.		

10 ISSUE	5				2 RD NUMBER	3 SECTION	4 SHEET
					8/4-32-059	1	2

## Retraction actuator assembly p/n 46550-7/-9



Remove the rod end of the retraction actuator assembly in accordance with SCR 086-07 rev. D

Inspect affected parts for any signs of corrosion or wear.


Provided the components are free of any damage re-assemble retraction actuator in accordance with SCR 086-07 rev. D

At Issue # 5: SCR086-07 Raised to Rev D from C



## **Bilag 33B**






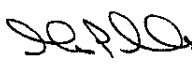
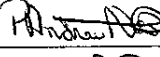
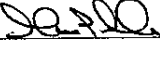
		<b>SERVICE CONCESSION REQUEST</b>			SCR NUMBER SCR 086-07	REV D	PROG 2130
		AIRCRAFT DETAILS			INDICATE IF <b>A.O.G.</b> ➤➤ <input checked="" type="checkbox"/> ⚡⚡		
EVENT DATE (Y/M/D)	AIRLINE	A/C S/N	TSN	CSN			
ANY	ALL	4001 AND SUB					
ITEM	PART NO.	NAME		S/N	TSN	CSN	
N.H.A ⇨							
N.H.A ⇨	46550-7/-9	RETRACTION ACTUATOR		ALL			
PART ⇨	46570-1/-3	PISTON		ALL			
<b>LIMITED FLIGHT REQUESTED</b> YES <input checked="" type="checkbox"/> NO <input type="checkbox"/> (IF YES, AUTHORIZED ENGINEER SIGNATURE REQUIRED)		REQUEST CATEGORY			AFFECTED SYSTEM		
		IN-SERVICE PROBLEM <input checked="" type="checkbox"/>			MLG <input checked="" type="checkbox"/>	BRAKING <input type="checkbox"/>	NLG <input type="checkbox"/>
INDICATE FC OR FH LIMITATION:		DISPOSITION SUMMARY			PREVIOUS CONCESSIONS GRANTED FOR THIS SERIAL NUMBER COMPONENT		
<b>FC* 1000 OR 6 MONTHS</b> *WHICH EVER COMES FIRST		NORMAL USE AFTER REPAIR <input type="checkbox"/> LIMITED SERVICE <input checked="" type="checkbox"/> TEMPORARY REPAIR <input type="checkbox"/> REMOVE & REPAIR <input checked="" type="checkbox"/> REPLACE PART <input checked="" type="checkbox"/>					
IF ONLY FC IS SPECIFIED INDICATE FH NOT RELEVANT <input type="checkbox"/> OR SPECIFY LIMITATION IN TERMS OF AIRCRAFT CHECKS: A <input type="checkbox"/> C <input type="checkbox"/> L <input type="checkbox"/> x							
SCR RAISED BY B WEBER					DATE RAISED 2007/09/12		


ITEM	PROBLEM DESCRIPTION
1	THERE HAVE BEEN 2 INSTANCES OF SEPARATION OF ROD END P/N P3A2750 AND PISTON P/N 46570-1/-3. INSPECTION OF THREAD CONDITION REQUIRED IN ACCORDANCE TO TRANSPORT CANADA AIRWORTHINESS DIRECTIVE (CF-2007-20).
REPORTED CAUSE OF PROBLEM:	
ADDITIONAL INFORMATION ATTACHED <input type="checkbox"/>	
➤➤ SEE SHEET 2 AND SUBS FOR MORE INFORMATION ⚡⚡	

		<b>SERVICE CONCESSION REQUEST</b>			SCR NUMBER	REV	PROG
					SCR 086-07	D	2130
<b>AIRCRAFT DETAILS</b>					INDICATE IF <b>A.O.G.</b> 		
EVENT DATE (Y/M/D)	AIRLINE	A/C S/N	TSN	CSN			
ANY	ALL	4001 AND SUB					
<b>ITEM</b>	<b>PART NO.</b>	<b>NAME</b>			<b>S/N</b>	<b>TSN</b>	<b>CSN</b>
N.H.A ⇔							
N.H.A ⇔	46550-7/-9	RETRACTION ACTUATOR			ALL		
PART ⇔	46570-1/-3	PISTON			ALL		

ITEM CONTINUATION SHEET / INSTRUCTIONS

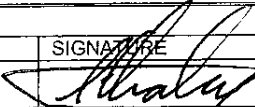
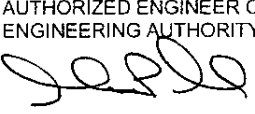
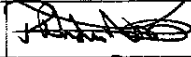

- |   |  |
|---|--|
| 1 | <ol style="list-style-type: none"> <li>1. SHUT DOWN HYDRAULIC SYSTEM 2</li> <li>2. WITH ACTUATOR INSTALLED ON AIRCRAFT, REMOVE LOCK WIRE AND BACK OFF JAM NUT AS REQUIRED TO DISENGAGE LOCKING FEATURE.</li> <li>3. DISASSEMBLE AS REQUIRED, REMOVE ACTUATOR ROD END PIN (P/N 46160-1) FROM MAIN LANDING GEAR SHOCK STRUT ASSEMBLY</li> <li>4. FULLY COMPRESS PISTON</li> <li>5. SECURE PISTON, AND REMOVE ROD END FROM PISTON.</li> <li>6. IF ROD END (P/N P3A2750) DOES NOT EASILY BACK OUT OF PISTON WITHOUT BINDING AND WITH THE USE OF A STRAP WRENCH, REMOVE RETRACT ACTUATOR P/N 46550-7/-9 FROM GEAR ASSEMBLY.                         <ul style="list-style-type: none"> <li>- REPLACE WITH NEW OR SERVICABLE RETRACT ACTUATOR P/N 46550-7/-9 IN ACCORDANCE WITH BOMBARDIER AMM. REPLACEMENT ACTUATOR SHALL HAVE CORROSION INHIBITING COMPOUND (CIC) INCORPORATED.</li> <li>- IF THE REPLACEMENT ACTUATOR DOES NOT HAVE CORROSION INHIBITING COMPOUND (CIC) APPLIED TO THE PISTON ROD/ROD END THREADS, IT MUST BE INCORPORATED WITHIN <b>500 FC</b> OF INITIAL INSPECTION, SEE <b>SECTION A</b> OF THIS SCR FOR INSTRUCTIONS.</li> </ul> </li> <li>7. IF ROD END (P/N P3A2750) BACKS OUT OF PISTON WITHOUT BINDING, COMPLETELY REMOVE ROD END AND CONTINUE WITH OPERATIONS 8 THRU 16.</li> <li>8. WIRE BRUSH WITH SOLVENT TO CLEAN THREADED AREAS OF PISTON AND ROD.</li> <li>9. VISUALLY INSPECT ROD END (P/N P3A2750) FOR EVIDENCE OF CORROSION CONTAMINATION IN THREADS UNDER ADEQUATE LIGHTING CONDITIONS.                         <ul style="list-style-type: none"> <li>- IF ANY EVIDENCE OF PITTING CORROSION IS FOUND ON ROD END THEN DISCARD THE ROD END.</li> </ul> </li> </ol> |
|---|--|



DISPOSITION AUTHORIZATION				AUTHORIZED ENGINEER OR HIGHER ENGINEERING AUTHORITY
	NAME (PRINT)	SIGNATURE	DATE(Y/M/D)	
ENGINEER	S.HEALEY		2007/09/20	 DATE: Sept 20, 2007
STRESS	A. NORTH		2007/09/20	
OTHER (SPECIFY)	M. PERRELLA		2007/09/20	
				<b>Page 2 of 7</b>

		<b>SERVICE CONCESSION REQUEST</b>			SCR NUMBER	REV	PROG
					SCR 086-07	D	2130
AIRCRAFT DETAILS					INDICATE IF <b>A.O.G.</b> ➤ ➤ ☒ ⏪ ⏩		
EVENT DATE (Y/M/D)	AIRLINE	A/C S/N	TSN	CSN			
ANY	ALL	4001 AND SUB					
ITEM	PART NO.	NAME			S/N	TSN	CSN
N.H.A ⇨							
N.H.A ⇨	46550-7/-9	RETRACTION ACTUATOR			ALL		
PART ⇨	46570-1/-3	PISTON			ALL		

**INSTRUCTIONS / CONTINUATION SHEET**

10. VISUALLY INSPECT PISTON (P/N 46570-1/-3) THREADS AND THREAD RELIEF AREA FOR EVIDENCE OF CORROSION AND/OR DAMAGE AND/OR PITTING (REF. FIGURE 1), USING BORESCOPE OR 10X MAGNIFICATION MIRROR UNDER ADEQUATE LIGHTING CONDITIONS.
- IF CORROSION IS FOUND IN THREADED AREA OF PISTON P/N 46570-1/-3 PERFORM REWORK IN ACCORDANCE WITH **SECTION B** OF THIS SCR
  - IF NO CORROSION IS FOUND CONTINUE WITH REMAINING OPERATIONS
- IF THE INITIAL VISUAL INSPECTION IS DONE WITHOUT USING BORESCOPE OR 10X MAGNIFICATION MIRROR PER THE REVISION NC OF THIS SCR, A ONE TIME DEFERRAL FOR UP TO **500 FC** IS PERMISSIBLE TO COMPLETE THE ABOVE INSPECTION (REF. OPERATION 10).
11. COAT ACTUATOR THREADS AND THREAD RELIEF AS WELL AS ROD END THREADS, WITH CORROSION INHIBITING COMPOUND MASTINOX 6856K OR CORBAN 27L WITHIN 500 FC OF INITIAL INSPECTION.
12. RE-INSTALL ROD END AND JAM NUT INTO PISTON ASSY
13. DISASSEMBLE AS REQUIRED TO REMOVE ACTUATOR FROM YOKE ASSEMBLY (NOTE: HYDRAULIC DISCONNECTION NOT REQUIRED).
14. USING TOOL NUMBER CG 56806, ADJUST ROD END RETRACTED LENGTH AS REQUIRED, TORQUE JAM NUT TO 660-980 IN-LBS, SAFETY LOCK WIRE PER MS 33540.
- OPTIONAL PROCEDURE FOR RIGGING ACTUATOR LENGTH: RIG ACTUATOR TO NOMINAL RETRACTED LENGTH PER TOOL DRAWING (REF DIM 4.286 INCH) AND TORQUE JAM NUT TO 660-980 IN-LBS, SAFETY LOCK WIRE PER MS33540.
  - NOTE: IF OPTIONAL PROCEDURE IS USED, GEAR SWINGS ARE REQUIRED (2 POWDERED CYCLES AND 1 ALTERNATE RELEASE TO VERIFY FUNCTIONAL CAPABILITY).

DISPOSITION AUTHORIZATION				AUTHORIZED ENGINEER OR HIGHER ENGINEERING AUTHORITY
	NAME (PRINT)	SIGNATURE	DATE (Y/M/D)	
ENGINEERING	S. HEALEY		2007/09/20	 DATE: Sept 20, 2007
STRESS	A. NORTH		2007/09/20	
OTHER (SPECIFY)	M. PERRELLA		2007/09/20	
				<b>Page 3 of 7</b>

		<b>SERVICE CONCESSION REQUEST</b>			SCR NUMBER	REV	PROG
					SCR 086-07	D	2130
AIRCRAFT DETAILS					INDICATE IF <b>A.O.G.</b> 		
EVENT DATE (Y/M/D)	AIRLINE	A/C S/N	TSN	CSN			
ANY	ALL	4001 AND SUB					
ITEM	PART NO.	NAME			S/N	TSN	CSN
N.H.A ⇨							
N.H.A ⇨	46550-7/-9	RETRACTION ACTUATOR			ALL		
PART ⇨	46570-1/-3	PISTON			ALL		

**INSTRUCTIONS / CONTINUATION SHEET**

15. RE-INSTALL ACTUATOR ONTO YOKE ASSEMBLY.
16. EXTEND PISTON AND RE-ATTACH TO SHOCK STRUT ASSEMBLY USING PIN P/N 46160-1, AND TORQUE IN ACCORDANCE AMM REQUIREMENTS.




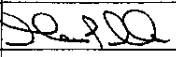
**SECTION A – APPLICABLE TO EXISTING ACTUATORS ASSEMBLED WITHOUT CIC**


1. DISASSEMBLE AS REQUIRED TO REMOVE ROD END P/N P3A2750 FROM ACTUATOR ASSEMBLY.
2. INSPECT - ENSURE NO EVIDENCE OF CORROSION ON ACTUATOR PISTON THREADS OR ROD END THREADS.
3. COAT ACTUATOR THREADS AND THREAD RELIEF AS WELL AS ROD END THREADS, WITH CIC MASTINOX 6856K OR CORBAN 27L, AND RE-INSTALL ROD END ONTO ACTUATOR ASSEMBLY.
4. ADJUST ACTUATOR RETRACTED LENGTH USING TOOL CG 56806 REQUIREMENTS OR IN ACCORDANCE WITH CMM 32-31-06 REQUIREMENTS. OPTIONAL PROCEDURE PER STEP 13, ABOVE, IS ALSO ACCEPTABLE
5. TORQUE JAM NUT TO 660-980 IN-LBS AND SAFETY LOCKWIRE PER MS 33540.

**REPEAT INSPECTION CRITERIA**

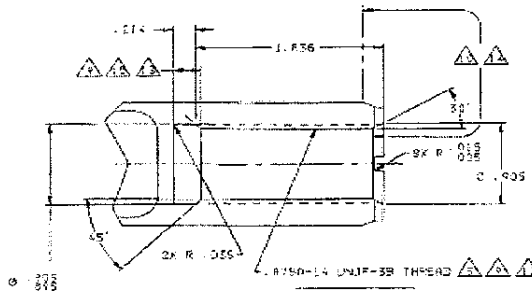
THESE INSPECTION CRITERIA SHALL APPLY TO ALL ACTUATORS EXCEPT THOSE REWORKED PER **SECTION B** OF THIS SCR. THESE CRITERIA SHALL REMAIN IN EFFECT UNTIL TERMINATION OF THE AIRWORTHINESS DIRECTIVE (CF-2007-20).

1. INSPECT RETRACT ACTUATOR TO ENSURE JAM NUT IS SECURE AND WIRE LOCK IS IN PLACE EVERY **250 FC** OR ONCE EVERY MONTH WHICH EVER OCCURS FIRST  
 A) IF JAM NUT IS FOUND LOOSE RE-TORQUE TO 660-980 INB-LBS AND SAFETY LOCKWIRE PER MS 33540.
2. INSPECT RETRACT ACTUATOR PISTON AND ROD END ASSEMBLY IN ACCORDANCE WITH THIS SCR OPERATIONS 1 THRU 16 ONCE EVERY **2000 FC** OR ONCE PER CALENDAR YEAR WHICH EVER OCCURS FIRST.

DISPOSITION AUTHORIZATION				
ENGINEERING	NAME (PRINT)	SIGNATURE	DATE(Y/M/D)	AUTHORIZED ENGINEER OR HIGHER ENGINEERING AUTHORITY   DATE: <b>Sept 20, 2007</b>
	S.HEALEY		2007/09/20	
STRESS	A. NORTH		2007/09/20	
OTHER (SPECIFY)	M. PERRELLA		2007/09/20	
				<b>Page 4 of 7</b>

		<b>SERVICE CONCESSION REQUEST</b>			SCR NUMBER SCR 086-07	REV D	PROG 2130
		AIRCRAFT DETAILS			INDICATE IF <b>A.O.G.</b> ➤➤ <input checked="" type="checkbox"/> ⚡⚡		
EVENT DATE (Y/M/D)	AIRLINE	A/C S/N	TSN	CSN			
ANY	ALL	4001 AND SUB					
ITEM	PART NO.	NAME		S/N	TSN	CSN	
N.H.A ➔							
N.H.A ➔	46550-7/-9	RETRACTION ACTUATOR		ALL			
PART ➔	46570-1/-3	PISTON		ALL			

**INSTRUCTIONS / CONTINUATION SHEET**



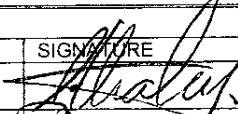

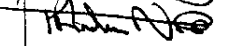

**FIGURE 1**


**SECTION B**

1. MASK AS REQUIRED TO PROTECT ACTUATOR HOUSING, GLAND AREA, AND EXPOSED CHROME OF PISTON FROM F.O.D CONTAMINATION AND DAMAGE DURING THE FOLLOWING REWORK.
2. CHASE PISTON THREADS AND THREAD RELIEF AREA TO REMOVE CORROSION PRODUCTS TO THE GREATEST POSSIBLE EXTENT USING THREAD COMB AND/OR STAINLESS STEEL WIRE BRUSH.
3. INSPECT THE ENTIRE PROFILE OF THREADS OVER THE FULL SPAN OF THREADS (REF. 1.836 DIM, FIGURE 1) AND THE RELIEF GROOVE IN PISTON USING 10X MAGNIFICATION MIRROR OR BORESCOPE UNDER ADEQUATE LIGHTING CONDITIONS.

**4. ACCEPTANCE CRITERIA/REWORK OPTIONS**

A) LIGHT SURFACE CORROSION (NO PITTING) OVER THE ENTIRE THREADED LENGTH WITH AT LEAST FIVE CONSECUTIVE FULL UNDAMAGED THREADS WITHIN THE ENGAGED THREAD LENGTH (REF FIGURE 2) IS ACCEPTABLE FOR **1000 FC OR 6 MONTHS** (WHICH EVER OCCURS FIRST) OF CONTINUED SERVICE. THE RETRACT ACTUATOR IS TO BE INSPECTED TO ENSURE JAM NUT IS SECURE AND WIRE LOCK IS IN PLACE EVERY **100 FC**

DISPOSITION AUTHORIZATION				
	NAME (PRINT)	SIGNATURE	DATE(Y/M/D)	AUTHORIZED ENGINEER OR HIGHER ENGINEERING AUTHORITY
ENGINEERING	S. HEALEY		2007/09/20	
STRESS	A. NORTH		2007/09/20	
OTHER (SPECIFY)	M. PERRELLA		2007/09/20	
				DATE: <b>Sept 20, 2007</b>
<b>Page 5 of 7</b>				

		<b>SERVICE CONCESSION REQUEST</b>			SCR NUMBER	REV	PROG
					SCR 086-07	D	2130
AIRCRAFT DETAILS					INDICATE IF <b>A.O.G.</b> >> <input checked="" type="checkbox"/> <<		
EVENT DATE (Y/M/D)	AIRLINE	A/C S/N	TSN	CSN			
ANY	ALL	4001 AND SUB					
ITEM	PART NO.	NAME			S/N	TSN	CSN
N.H.A ⇨							
N.H.A ⇨	46550-7/-9	RETRACTION ACTUATOR			ALL		
PART ⇨	46570-1/-3	PISTON			ALL		

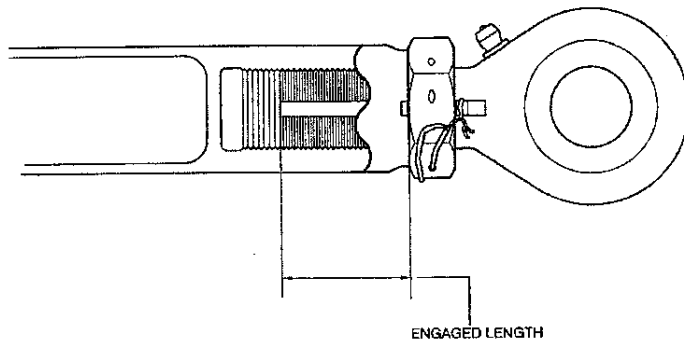
**INSTRUCTIONS / CONTINUATION SHEET**

B) EVIDENCE OF MODERATE PITTING CORROSION CAN BE REWORKED: (REF FIG 2)

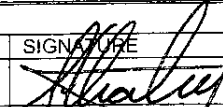

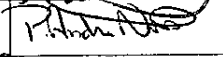

- a. TO DWG S2116 (HELICOIL SOLUTION). HELICOIL REWORK IS ACCEPTABLE FOR **1000 FC OR 6 MONTHS** (WHICH EVER OCCURS FIRST) OF CONTINUED SERVICE.
- b. REPLACED




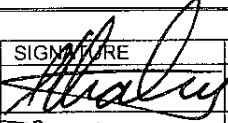
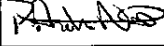
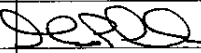
FOR OPTION a) THE RETRACT ACTUATOR IS TO BE INSPECTED TO ENSURE JAM NUT IS SECURE AND WIRE LOCK IS IN PLACE EVERY **100 FC**.

IF JAM NUT IS FOUND LOOSE DURING FLIGHT CYCLE ALLOWANCES GRANTED BY THE CRITERIA IN 4A) OR 4 B), RE-TORQUE JAM NUT TO 660-980 INB-LBS AND SAFETY LOCKWIRE PER MS 33540.



**FIGURE 2**

DISPOSITION AUTHORIZATION				
	NAME (PRINT)	SIGNATURE	DATE(Y/M/D)	AUTHORIZED ENGINEER OR HIGHER ENGINEERING AUTHORITY
ENGINEERING	S. HEALEY		2007/09/20	 DATE: <b>Sept 20, 2007</b>
STRESS	A. NORTH		2007/09/20	
OTHER (SPECIFY)	M. PERRELLA		2007/09/20	
				<b>Page 6 of 7</b>

		<b>SERVICE CONCESSION REQUEST</b>			SCR NUMBER SCR 086-07	REV D	PROG 2130
		AIRCRAFT DETAILS			INDICATE IF <b>A.O.G.</b> 		
EVENT DATE (Y/M/D)	AIRLINE	A/C S/N	TSN	CSN			
ANY	ALL	4001 AND SUB					
ITEM	PART NO.	NAME		S/N	TSN	CSN	
N.H.A ⇨							
N.H.A ⇨	46550-7/-9	RETRACTION ACTUATOR		ALL			
PART ⇨	46570-1/-3	PISTON		ALL			
<b>INSTRUCTIONS / CONTINUATION SHEET</b>							
<p><b><u>SUGGESTED LIST OF CIC SUPPLIERS:</u></b></p> <p>CORBAN 27L      <a href="http://www.zipchem.com/locations.aspx">http://www.zipchem.com/locations.aspx</a></p> <p>MASTINOX 6856K      <a href="http://www.ppg.com/prc-desoto/main.asp?img=crt&amp;contLvl=mansites">http://www.ppg.com/prc-desoto/main.asp?img=crt&amp;contLvl=mansites</a></p> <p><b><u>DEFINITIONS</u></b></p> <p>SURFACE CORROSION : a uniform loss of metal due to corrosion</p> <p>PITTING CORROSION : a localized attack which results in a depression or a pit</p>							
<b>DISPOSITION AUTHORIZATION</b>							
	NAME (PRINT)	SIGNATURE	DATE(Y/M/D)	AUTHORIZED ENGINEER OR HIGHER ENGINEERING AUTHORITY  DATE: Sept 20, 2007			
ENGINEERING	S. HEALEY		2007/09/20				
STRESS	A. NORTH		2007/09/20				
OTHER (SPECIFY)	M. PERRELLA		2007/09/20				
				<b>Page 7 of 7</b>			





## **Bilag 34**





**Aircraft Accident Notification Report  
SK2867/27OCT2007**

**Occurrence**

Information	Specification/Description
Date	27 OCT 2007
Time	1457 UTC
Location	CPH-EKCH Copenhagen - Denmark Longitude: 12, 39, 21 E Latitude: 55,37,5 N Elevation: 17 ft
Last point of departure	BGO- ENBR (Flesland-Bergen) Off block 1230 UTC Airborne 1236 UTC
Point of Intended Landing	CPH-EKCH Copenhagen Airport
Flight number	SK2867
Radio Call sign	Scandinavian 2867
Type of operations	Commercial
Phase of operation	Landing CPH-EKCH TD 1450 UTC
Flight level	N/A
Description of the occurrence	Malfunction LDG extension. Was unable to extend Right Main Landing Gear.
Fire	No
Other	No injuries reported.

**Aircraft Information**

Information	Specification/Description
Manufacture	Bombardier Aerospace Inc.
Model	DHC-8-403 Euro 76 Seats
Registration	LNRDI -4024 Asta Viking
Serial number	MSN 4024
Year of manufacture	2000 Date of acceptance 23 SEP 2000 In service 30 Sep 2000
Cert. of Airworthiness, exp, date	30 Sept 2008
Total time / cycles	FH 12071,36 FC 14967
Time since last maintenance and type of maintenance	L-Check 2007-10-12 A-Check 2007-09-01

Engine(s) type and model	PW150A / 4580 SHP
Propeller(s)/rotor(s), manufacture and type	Dowty Aerospace Propellers - R408/6-123-F/1
Total time / cycles	<p>APU and Engine Information</p> <p>APU PN 4503067A SN SP-E994531  TSI = 12071,36 FH  TSI = 14967 FC  TSN = 12071,36 FH  TSN = 14967 FC  TSMInor = 12071,36 FH  TSMInor = 14967 FC  TSO = 12071,36 FH  TSO = 14967 FC</p> <p>LH Engine PN 3121627-01 SN PCE-FA0123  TSI = 887,14 FH  TSI = 993 FC  TSN = 9489,14 FH  TSN = 11147 FC  TSMInor = 9489,14 FH  TSMInor = 11147 FC  TSO = 9489,14 FH  TSO = 11147 FC</p> <p>RH Engine PN 3121627-01 SN PCE-FA0070  TSI = 39,5 FH  TSI = 44 FC  TSN = 9458,5 FH  TSN = 10718 FC  TSMInor = 39,5 FH  TSMInor = 44 FC  TSO = 9458,5 FH  TSO = 10718 FC</p>

Landing Gear	<p>NLG</p> <p>PN 47200-15 SN MAL0018  TSI = 212,84 FH  TSI = 226 FC  TSN = 11883,84 FH  TSN = 14880 FC  TSO = 11883,84 FH  TSO = 14880 FC</p> <p>LH MLG  PN 46100-29 SN MA0022  TSI = 12071,36 FH  TSI = 14967 FC  TSN = 12071,36 FH  TSN = 14967 FC  TSO = 12071,36 FH  TSO = 14967 FC</p> <p>RH MLG  PN 46100-29 SN MA0056  TSI = 12071,36 FH  TSI = 14967 FC  TSN = 12071,36 FH  TSN = 14967 FC  TSO = 12071,36 FH  TSO = 14967 FC</p>
--------------	---

Insurance company	AON Aviation
Insurance company's address	8 Devonshire Square London-UK
Insurance company's phone number	+44 207 623 55 00
Exp. date	Issued 30 Nov 2006 Valid until Midnight 30 <sup>th</sup> November 2007
Certificate of Airworthiness	Number N/A Validity 30 Sept 2008
Owner	USK Grampus Co Ltd 6-1, Nishishinjuku 1-chome Shinjuku-ku Tokyo 163-1508 Japan Sold to and leased back from USK Grampus Co., Ltd. 30JUN03. Ex version 8401 01MAR07.
Operator	Scandinavian Airlines System SE 19587 Stockholm, Sweden +46 8 797 00 00
Damage to Aircraft	Damage to hull Outer R/H wing tip damage NLG damage
Fire	No
Total number of persons onboard	38 Adults, 0 Child and 2 infants Above includes 2 passive crew.
Crew	2/2
Passengers	38 adults
Infants	2







**Weather details at time of occurrence****EKCH local weather 27OCT07, Based on METAR 1520 UTC**

Information		Specification/Description
Wind	Direction	110 deg
	Velocity	03 Kts
Gust	Direction	Nil
	Velocity	Nil
Turbulence	None/Light	None
	Moderate/severe	-----
Visibility	Visibility (m)	8000 Metres
	RVR	
Temperature	Dew point	08 C
	OAT	10 C
Pressure	QNH	1026
Clouds	Type amount	FEW014, BKN033
	Height	
Precipitation	None/Rain	None
	Drizzle/Snow	
	RASN/Hail	
Intensity	Light/Showers	N/A
	Moderate/Severe	
Icing	None/Light	No info
Light conditions	Daylight	Yes
General weather in the area	VMC	VMC
	IMC	

**Other information**

**SAS DHC-Q400 fleet was grounded by NPH Technical Operations, Geir Steiro, at 1445 UTC.**

NPH Scandinavian Flight Operations	NPH Scandinavian Technical Operations	NPH Scandinavian Ground Operations	NPH Crew Training
Stockholm 27 Oct 2007	Stockholm 27 Oct 2007	Stockholm 27 Oct 2007	Stockholm 27 Oct 2007
			
Ola Reinholdt	Geir Steiro	Tomas Linden	Torben Løvetofte





## **Bilag 34A**





2007-10-27

STK 2007- 0280-16

De skandinaviske luftfartsmyndigheternas  
samarbetsorgan för flygsäkerhetsfrågor

**STK** DET SKANDINAVISKE TILSYNSKONTOR  
DENMARK NORWAY SWEDEN

Accountable Manager  
John Dueholm  
Scandinavian Airlines System  
Denmark-Norway-Sweden  
STODA

Copy:  
STODO  
STOOF  
STOOM  
STODO-X  
STODG

### **Midlertidig inddragelse af luftdygtighedsbeviser på luftfartøjer af typen Bombardier DHC8-Q400.**

Dette brev bekræfter OPS-utvalgets beslutning om, med øjeblikkelig virkning, at inddrage luftdygtighedsbeviserne på samtlige luftfartøjer av ovennævnte type opereret af SAS, eller udlejet af SAS til anden luftfartsvirksomhed med fortsat registrering på dansk, norsk eller svensk register.

Ovennævnte er i overensstemmelse med hvad der blev meddelt SAS kl 17.00 dags dato via telefon af undertegnede.

Beslutningen er truffet på baggrund af havari med luftfartøjet LN-RDI den 27. oktober 2007 i København.

Luftdygtighedsbeviserne inddrages med hjemmel i Kommissionsforordning 1702/2003 Part 21, §21B330, idet luftfartøjstypen på baggrund af det indtrufne havari ikke overholder kravene i forordningens §21A181(a)1.

OPS-utvalget meddeler SAS når luftdygtighedsbeviserne igen kan udleveres.

Inddragelsen omfatter følgende luftfartøjsindivider:

LN-RDA, LN-RDB, LN-RDC, LN-RDD, LN-RDE, LN-RDF, LN-RDG, LN-RDH,  
LN-RDJ, LN-RDL, LN-RDM, LN-RDO, LN-RDP, LN-RDQ, LN-RDR, LN-RDT,  
OY-KCD, OY-KCE, OY-KCF og OY-KCG.

På vägnarna av luftfartsmyndigheterna i Danmark, Norge och Sverige.

*för Kurt Erik Mathiesen*  
Kurt Lykstoft Larsen  
Ordförande OPS-utvalget

STK - Det Skandinaviske Tilsynskontor  
Luftfartsstyrelsen  
SE-601 73 NORRKÖPING  
Visiting address: Bergkällavägen 32  
SOLLENTUNA, Sweden

Phone  
+ 46 (0)11 41 52100

E-mail: [stk@luftfartsstyrelsen.se](mailto:stk@luftfartsstyrelsen.se)  
SITA CODE BMAZVSK

Facsimile  
+ 46 (0)11 41 52490



## **Bilag 35**



## FORELØBIG REDEGØRELSE

29-10-2007

<b>HCLJ510-000449</b>	<b>Havari</b>		
Luftfartøj:	Dash 8-Q400	Registrering:	LN-RDI
Motorer:	2 PW150A	Flyvning:	Ruteflyvning, IFR
Besætning:	4 – ingen tilskadekomne	Passagerer:	40 – ingen tilskadekomne
Sted:	Københavns internationale lufthavn, Kastrup (EKCH)	Dato og tidspunkt:	27.10.2007 kl. 14:53 UTC

### Flyvnings historie

Flyvningen, hvorunder havariet indtraf, var en ruteflyvning fra Bergen international lufthavn, Flesland (ENBR) i Norge til Københavns internationale lufthavn, Kastrup (EKCH) i Danmark.

Flyvningen fra ENBR indtil anflyvning af EKCH forløb uden anmærkninger.

Under anflyvningen til EKCH blev betjeningshåndtaget for luftfartøjets understel valgt til udfældet position. Da udfældningssekvensen for understellet var afsluttet, viste indikationerne i cockpittet to grønne lys og et rødt lys. De to grønne lys indikerede at det venstre hovedunderstel og næseunderstellet var fuldt udfældet og i låst position. Det røde lys indikerede, at det højre hovedunderstel ikke var fuldt udfældet og i låst position. Cockpitbesætning afbrød anflyvningen.

En passager (en pilot ansat hos en anden operatør) henledte kabinebesætningens opmærksomhed på, at højre hovedunderstel kun var delvist udfældet.

Understellet blev indfældet og derefter udfældet igen. Under indfældning fungerede understellet som normalt, men under udfældning kom det højre hovedunderstel kun delvist ud. Ikke hele understellet, men kun en del af understelshjulet var synligt fra kabinen.

Understellet blev valgt indfældet, og den alternative understelsudfældningsprocedure (nødprocedure) blev udført. Indikationerne i cockpittet viste stadigvæk, at det højre hovedunderstel ikke var fuldt udfældet og låst. Besætningen bekræftede visuelt understellets position.

Luftfartøjet blev forberedt for en nødlanding, og passagererne blev flyttet for at fremme en hurtig evakuering af luftfartøjet efter landingen. Under forberedelserne for nødlanding, blev passagererne først briefet samlet og derefter individuelt for at sikre, at evakueringsprocedurerne var dem kendt.

Forud for landingen blev luftfartøjets højre motor stoppet og propellerne kantstillet.

Landingen blev foretaget på bane 04R med brand- og redningstjenesten i position. Luftfartøjet blev sat på det venstre hovedunderstel, og den venstre motor blev fuldt reverseret. Luftfartøjet forblev nær banens centerlinie under de første 400 meter, hvorefter det begyndte at dreje mod højre. På den tilstødende taxivej kom luftfartøjet til hvile på dets højre bagerste del af kroppen (fuselagen), den højre propel og den højre vingetip.

Luftfartøjet blev evakueret i løbet af cirka 30 sekunder ved brug af venstre sides to nødudgange.

Luftfartøjet blev ved havariet væsentligt beskadiget.

Havariet indtraf i dagslys og under meteorologiske instrument vejrforhold (IMC).

### **Teknisk undersøgelse**

Under bjærgningen af luftfartøjet forblev det højre hovedunderstel hængende i den delvis udfældede position.

Det højre hovedunderstel blev inspiceret, og der kunne ikke ved umiddelbar visuel inspektion observeres skader, fejl eller mangler, som kunne have resulteret i den manglende udfældning af understellet.

For at kunne udfælde det højre hovedunderstel blev understelsaktuatoren (retraction/extension actuator) demonteret for manuelt at kunne udfælde og låse understellet. Aktuatoren var i intakt stand og øjebolten var fastgjort i aktuatorstemplet. Låsepinde til understellet blev monteret og luftfartøjet blev bugseret til en hangar.

Den tekniske undersøgelse er fokuseret omkring det højre understel og aktuormekanismen.

Med henblik på at isolere fejlen blev en brugsklar aktuator monteret på højre hovedunderstel, hvorefter understellet og dets system blev funktionstestet. Understellet og systemet fungerede normalt.

Den demonterede aktuator blev undersøgt detaljeret.

Undersøgelsen afdækkede, at en begrænser (orifice) i aktuatoren var blokeret, hvilket havde forhindret det højre hovedunderstel i at blive fuldt udfældet. Dette afdækkende forhold er ikke sammenligneligt med forholdene i de to tidligere havarier med luftfartøjstypen indtruffet i september måned 2007.

Kilden til blokeringen af begrænseren er ukendt på dette tidspunkt.

Havarikommissionens undersøgelser fortsættes.



## **Bilag 36**



## FORELØBIG REDEGØRELSE 30.10.2007

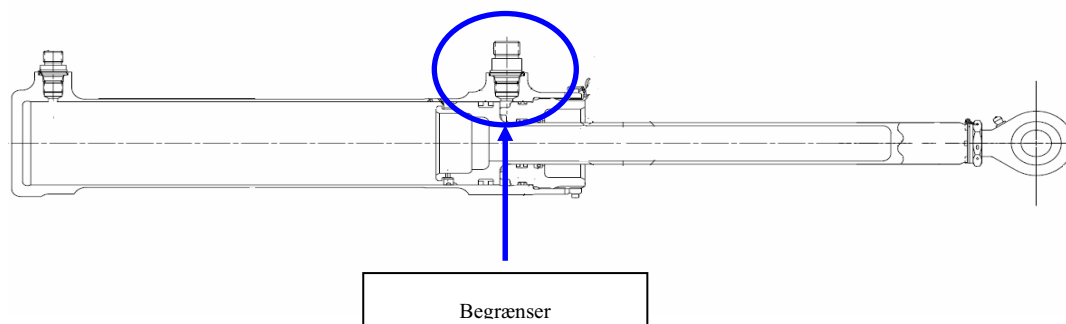
<b>HCLJ510-000449</b>	<b>Havari</b>		
Luftfartøj:	Dash 8-Q400	Registrering:	LN-RDI
Motorer:	2 PW150A	Flyvning:	Ruteflyvning, IFR
Besætning:	4 – ingen tilskadekomne	Passagerer:	40 – ingen tilskadekomne
Sted:	Københavns internationale lufthavn, Kastrup (EKCH)	Dato og tidspunkt:	27.10.2007 kl. 14:53 UTC

### Foreløbigt resultat af den tekniske undersøgelse af højre understels aktuator system

De udførte undersøgelser afdækkede, at en begrænser (orifice) i aktuatoren var blokeret, hvilket havde forhindret det højre hovedunderstel i at blive fuldt udfældet. Dette afdækkende forhold er ikke sammenligneligt med forholdene i de to tidligere havarier med luftfartøjstypen indtruffet i september måned 2007.

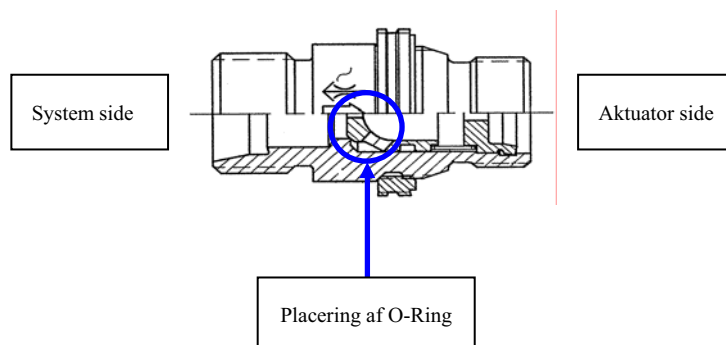
Den berørte aktuator blev demonteret og bragt til en undersøgelsesfacilitet for en detaljeret undersøgelse.

Nedenstående figur viser højre understels aktuator (retraction/extension actuator assembly) og placeringen af den blokerede begrænser.



Begrænseren (retraction/extension actuator restrictor valve) var blokeret af en O-ring. O-ringen kom ikke fra aktuatoren, og dens oprindelse er indtil videre ukendt.

Nedenstående figur viser begrænseren (retraction/extension actuator restrictor valve) og den position, hvor O-ringen som blokerede begrænseren blev lokaliseret.



Den utilsigtede tilstedeværelse af O-ringen og de deraf afledte konsekvenser, vurderes på det foreliggende grundlag til kun at berøre dette luftfartøj.

Den videre undersøgelse vil fokusere på oprindelsen af O-ringen.



## **Bilag 37**



## FORELØBIG REDEGØRELSE

03-11-2007

<b>HCLJ510-000449</b>	<b>Havari</b>		
Luftfartøj:	Dash 8-Q400	Registrering:	LN-RDI
Motorer:	2 PW150A	Flyvning:	Ruteflyvning, IFR
Besætning:	4 – ingen tilskadekomne	Passagerer:	40 – ingen tilskadekomne
Sted:	Københavns internationale lufthavn, Kastrup (EKCH)	Dato og tidspunkt:	27.10.2007 kl. 14:53 UTC

### Opdatering af undersøgelsesstatus

Ved undersøgelsen af højre hovedunderstels aktuator blev det afdækket, at en O-ring havde blokeret en begrænser (orifice) i aktuatoren. O-ringens blokering af begrænseren havde forhindret det højre hovedunderstel i at blive fuldt udfældet.

O-ringens fysiske dimensioner svarede til dimensionerne for en O-ring af typen NAS1611-110, identificeret på en fabrikationstegning for understeldørens solenoid sequence valve (SSV).

Havarikommissionens undersøgelser har samtidig afdækket, at den eneste komponent i landingsunderstelssystemet, som har monteret en O-ring af denne type, er en SSV.

Ved en gennemgang af luftfartøjets vedligeholdelsehistorik blev det blotlagt, at en SSV blev udskiftet den 16. oktober 2007. Denne SSV blev lokaliseret og undersøgt nærmere.

Den nærmere undersøgelse af denne SSV fra det højre hovedunderstel afdækkede, at et filterelement og en O-ring manglende i komponenten.

En tilsvarende O-ring fra en anden SSV blev demonteret og analyseret for at fastslå eventuelle ligheder med den O-ring, som havde blokeret begrænseren. Analysen viste, at dens fysiske dimensioner og materiale var identisk med dimensionerne og materialesammensætningen i den O-ring, der blokerede begrænseren.

I forbindelse med Havarikommissionens undersøgelser blev det bekendt, at der havde været tidligere hændelser, hvor filterelementer placeret sammen med O-ringen i SSV kollapsede og dermed kom ud i hovedunderstellets hydraulik system. I disse hændelser er det ikke Havarikommissionen bekendt, at O-ringene samtidig har løsnet sig fra SSV og dermed kommet ud i understellets hydraulik system.

Havarikommissionen har imidlertid konkluderet, at den fundne O-ring, der blokerede begrænseren, kom fra den SSV, som tidligere havde været monteret på luftfartøjet.

Ved en gennemgang af luftfartøjets hydrauliksystem, kunne det konkluderes, at O-ringen ikke kunne vandre fra SSV til den fundne position i begrænseren i det højre hovedunderstels aktuator. Denne konklusion underbygges af en detaljeret analyse af hydrauliksystemets ventiler, rørdeler, rørforbindelser og tilslutningsstudse, som befinder sig mellem de to komponenter. Analysen viste, at

nogle af disse dele ville tillade en fri passage af O-ringen, mens andre dele, såsom den mechanical sequence valve (MSV), er af et sådan design, at O-ringen ikke ville kunne passere gennem disse.

En yderligere gennemgang af luftfartøjets vedligeholdelseshistorik viste, at det højre hovedunderstels MSV blev udskiftet den 22. oktober 2007.

I henhold til vedligeholdelsesdokumenterne blev der leveret en MSV P/N 48303-7 der som udgangspunkt er konfigureret for montering i næseunderstelssystemet. Forud for monteringen på luftfartøjet, blev den leverede MSV ændret til en MSV P/N 48303-5 af vedligeholdelsespersonalet. For at ændre MSV P/N 48303-7 til en MSV P/N 48303-5, var det nødvendigt at ombytte tilslutningsstudsene fra den afmonterede MSV til den MSV, som skulle monteres på luftfartøjet.

I forbindelse med udskiftningen af MSV, kunne O-ringen, fundet i den blokerede begrænser i aktuatoren, blive omflyttet fra den ene side af MSV til den anden side, skjult i en tilslutningsstuds, uden at dette ville komme til vedligeholdelsespersonalets kendskab.

Efter den mulige overflytning af O-ringen, ville den kunne bevæge sig frit via det hydrauliske system frem til begrænseren i det højre hovedunderstels aktuator og derved blokere denne.

Havarikommissionens undersøgelse fortsættes.



## **Bilag 38**



LN- <i>RDI</i>	Flytype <i>Q400</i>
OY-	
SE-	

Flyet er besiktet med følgende resultat:

Anmerkninger <i>Tekniske handlingar och dokument granskade med referens till skrivelsev STH 2007-0280-3 och STH 2007-0280-4.  utan anmärkning</i>	Pålagt direktiv om utbedring
--	------------------------------

Luftdyktighetsbeviset er fornyet etter utført granskning.

Andre opplysninger

---

Luftdyktighetsbeviset er fornyet i henhold til de rutiner og instruksjer som til enhver tid gjelder for STK

Beviset gyldig til

*30 Sep 2008*

Sted og dato

*Budda 12 okt 2007*

Underskrift

*Jan Svensson*

Jan Svensson  
Inspector  
Luftfartstilsynelsen

Fordelning: Hvit til SAS

Blå til STK sentralkontor

Röd beholdes av lokal STK

Gul til nationell myndighet



STK  
Luftfartsstyrelsen

SE-601 73 NORRKÖPING

Ref OM 072/07

Telefax +4687974010  
Mobil +46 0709971891  
e-post p-o.andersson@sas.se

12 Oct 2007

## Q400 LN-RDI Återaktivering av C of A

Med referens till OPS-utvalgets brev STK 2007-0280-3 och STK 2007-0280-4 översändes härmed följande dokumentation som visar att SAS uppfyller kraven för att LN-RDI:s C of A kan återaktiveras.

- ✓ 1) Genomfört EASA EAD No:2007-0252-EAD Ref EO-Q400-320061 EO-Q400-320064 EO-Q400-320064 omfattar installation av actuator vä och hö sida samt funktionsprov av landing gear. Ref bifogade jobcard EOQ320061 och EOQ320064
- ✓ 2 o 3) Installation av ny rod-ends och piston i actuator framgår av FORM ONE på respektive actuator vars installation framgår av dirty fingerprints/jobcards för EO-Q400-320064
- ✓ 4) AD-status framgår av bifogade AD Compliance List för Landing gear. Ref bifogade AD-lista på LDG
- ✓ 5) Härmed intygas att det inte finns några kvarstående HIL-or MEL-items eller några dispenserade maintenance task på LDG installationen. Ref bifogade print out på MEL/HIL-status
- ✓ 6) Genomfört inspektion enligt Bombardie AOM249B ref EO-Q400-320066, EO-Q400-320067 och EO-Q400-320072 Ref bifogade jobcard EOQ320066, EOQ320067 och EOQ320072

Yours sincerely

Scandinavian Airlines System  
Technical Operations





P-O Andersson  
Director Airworthiness & Documentation

Bilagor.

WU 070911

SAS	WPID:	JOBSEQ:	CHTYP/PART:	ACREG/BOWID: RDI
JOB CARD NAME:	REWORK OF NLG DOOR MECH. DEBRIS GUARD			JOBID: FREQ400-320072
ACTYP: Q400	ACEFFCD:	ACSNORG: 4024	ZONE: 711	ZONE: JOB CARD: EQQ320072
SKILL:	SKILL:	SKILL:	SKILL:	SKILL: Rev: n
ISSUED BY: CPHTU/LCE	ISSUE DATE: 2007-09-26			PAGE: 1 OF 1

**COPY**

A/C REG.		JOB CARD NO.	
ATTACH:		ATTACH:	
AMM 1:	PAGEBLOCK:	CODE:	AMM 5:
AMM 2:	PAGEBLOCK:	CODE:	AMM 6:
AMM 3:	PAGEBLOCK:	CODE:	AMM 7:
AMM 4:	PAGEBLOCK:	CODE:	AMM 8:
COMPNO:	OUTSN:	PN:	SNORG:
COMPNO:	INSN:	PN:	SNORG: STS/DK
STATION: STS	DATE: 9/10-07	SIGNATURE: <i>[Signature]</i>	0.1 5-0157

- JOB ATTACHMENT: PDF EQQ320072.pdf
- JOB ATTACHMENT: PDF RD84-32-064.pdf
- JOB ATTACHMENT: PDF RD84-51-030.pdf

**ZONE:** 711 Nose gear

**Subject:**

**Consumables:**

Qty	Part-No	Unit	Description
1	See Consumable list on attachment	EACH	Consumable list





MAINTENANCE TASK CARD MANUAL

Aircraft S/N / Acreg..		Aircraft series Q400	Aircraft Effectivity ALL	Task Card Number EOQ320072
Issued by & Date		Airline designator Code		JOBID
CPHMR-U / LCE	26SEP07	SK		FREO400-320072

**Subject:**

Q400 – Rework instruction for trimming the lower edge of the NLG Door Mechanism Debris Guard to remove/prevent chafe damage with the spring assembly

**Resp. Eng:**

CPHMRS /Frank Møller

**Reference:**

RFQ ME-70329  
Bombardier RD8/4-32-064

**Reason:**

This EO is being issued in order to trim the debris guard p/n 83220012 to eliminate the possibility of chaffing between the debris shield and the NLG forward door spring.

**Note:**

This EO must be performed before EO-Q400-320064

**Classification:**

Minor Modification

**Consumables:**

#	P/N:	Subject:	Qty	Note
1.	RMC 300-175-01	Epoxy adhesive EA934NA	A/R	
2.	RMC 720-004-02	Epoxy primer	A/R	
3.	RMC 724-429-01	Top coat (pearl grey)	A/R	
4.	RMC 724-419-XX	Hardener for topcoat	A/R	
5.	RMC 729-096-XX	Activator for topcoat	A/R	

DI STSDK ~~Perk~~

5-2330 ~~STSDK~~

5-2330

STSDK

Q.1

-5-0429

**Accomplishment instruction**

1. Remove Debris Guard Panel p/n 83220012
2. Perform Bombardier RD8/4-32064, latest revision.
3. Install Debris Guard Panel p/n 83220012

**Note:** Step 6. of Bombardier RD8/4-32-064 is not required – this will be called out when the spring is installed.




WPID:                      JOBSEQ:                      CHYTP/PART:                      ACREG/BOWID: **RDI**

JOB CARD NAME: **INSTALLATION OF NLG FWD DOOR SPRING**                      JOBID: **FREQ400-320067**

ACTY: **Q400**    ACEFCD:                      ACSNORG: **4024**    ZONE: **710**    ZONE:                      ZONE:                      JOB CARD: **EOQ320067**

SKILL:                      SKILL:                      SKILL:                      SKILL:                      SKILL:                      TO rev: **0**

ISSUED BY: **CPHTEU/KP**                      ISSUE DATE: **2007-09-26**                      PAGE: **1 OF 1**

A/C REG. 		JOB CARD NO. 	
ATTACH: ATTACH:		ATTACH: ATTACH:	
AMM 1: PAGEBLOCK: CODE:	AMM 5: PAGEBLOCK: CODE:	AMM 2: PAGEBLOCK: CODE:	AMM 6: PAGEBLOCK: CODE:
AMM 3: PAGEBLOCK: CODE:	AMM 7: PAGEBLOCK: CODE:	AMM 4: PAGEBLOCK: CODE:	AMM 8: PAGEBLOCK: CODE:
COMPNO:                      OUTSN:                      PN:	SNORG:	POS:	
COMPNO:                      INSN:                      PN:	SNORG: <b>STS/DK</b>	VER: 1	
STATION: <b>STS</b>	DATE: <b>12/07</b>	SIGNATURE: 	<b>DI 2-1603</b>

JOB ATTACHMENT: PDF EOQ320067.pdf

JOB ATTACHMENT: AMM 32-22-16-400-801-000-001

ZONE: 710 Nose gear and doors

Subject:

Materials:

Qty	Part-No	Unit	Description
1	See material list on	EACH	TO front page.

**SAS**

## MAINTENANCE TASK CARD MANUAL

Aircraft S/N / Acreg..		Aircraft series Q400	Aircraft Effectivity ALL	Job Card Number EQQ320067
Issued by & Date CPHMR/KP 26 Sep. 2007		Airline designator Code SK		JOBID FREO400-320067

**Subject:****Q400 - Installation of NLG forward door spring****Responsible Engineering:**

CPHMRS/Frank Møller

**Reference:**

AMM 32-00-00-840-801

AMM 32-22-16-420-001

Bombardier AOM 249D

Goodrich SCR 101-07C

**Reason:**

This EO is issued due to an incident in which the Nose Landing Gear failed to extend. Based on preliminary investigations results a one time inspection of the NLG forward door spring has been carried out iaw. EO-Q400-320066. Installation of serviceable spring is done iaw. this EO-Q400-320067.

**Classification:**

Not Applic.

**Materials:**

#	P/N:	Subject:	Qty	Note
1.	47844-1	Spring	1	
2.	MS24665-153	Cotterpin	2	
3.	RMC 691-016-01	Aeroshell Grease 7	A/R	



DI  
STS/DK  
DI  
2-1603Perf.  
STS/DK  
x-0011**Accomplishment instruction**

1. Refer to AMM Task 32-00-00-840-801 and open and lock the nose and main landing gear doors.
2. Install spring p/n 47844-1 - apply a thin film of grease (RMC 691-016-01) to the pin. Ref AMM 32-22-16-400-801 pkt. 4 (Procedure) A (1) (a) 1. through 6.
3. Inspect the NLG door Mechanism to ensure that there is no fouling of the spring assembly with the debris guard p/n 83220012 through the full range of motion.

STS/DK  
DI  
2-1603STS/DK  
x-0011STS/DK  
x-0011

**NOTE:** To facilitate this inspection, the LH NLG door push rod may be temporarily disconnected to gain better access to inspect for any fouling condition through the full range of motion



SAS	WPID:	JOBSEQ:	CHTYP/PART:	ACREG/BOWID: RDI302
JOBCARDNAME: REMOVE AND INSPECT NLG FWD DOOR SPRING				JOBID: FREO400-320066
ACTYP: Q400	ACEFFCD:	ACSNOG: 4024	ZONE: 710	ZONE: ZONE: JOBCARD: EQQ320066
SKILL:	SKILL:	SKILL:	SKILL:	SKILL: TO rev: n
ISSUED BY: CPHTEU/LCE	ISSUE DATE: 2007-09-25			PAGE: 1 OF 1
A/C REG.		JOBCARD NO.		
ATTACH:		ATTACH:		
ATTACH:		ATTACH:		
AMM 1:	PAGEBLOCK:	CODE:	AMM 5:	PAGEBLOCK:
AMM 2:	PAGEBLOCK:	CODE:	AMM 6:	PAGEBLOCK:
AMM 3:	PAGEBLOCK:	CODE:	AMM 7:	PAGEBLOCK:
AMM 4:	PAGEBLOCK:	CODE:	AMM 8:	PAGEBLOCK:
COMPNO:	OUTSN:	PN:	SNORG:	POS:
COMPNO:	INSN:	PN:	SNORG:	VER: 1
STATION: STS	DATE: 26/09/07	SIGNATURE: <i>Mah</i>	Q1	
			E-1674	

\*\*\*\*\*  
 \* ATTENTION RESPONSIBLE PLANNING: Mandatory Report Form on the last page. \*  
 \*  
 \*\*\*\*\*

JOB ATTACHMENT: PDF EQQ320066.pdf

ZONE: 710 Nose gear and doors

Subject:

COPY



MAINTENANCE TASK CARD MANUAL

Aircraft S/N / Acreg..		Aircraft series Q400	Aircraft Effectivity ALL	Job Card Number EOQ320066
Issued by & Date		Airline designator Code		JOBID
CPHMR-U / LCE	25SEP07	SK		FREQ400-320066

**Subject:**

Q400 – Removal and NDT Inspection of NLG forward door spring

**Responsible Engineering:**

CPHMRS/Frank Møller

**Reference:**

RFQ ME-70239  
Bombardier AOM 249B  
Goodrich SCR 101-07B

**Reason:**

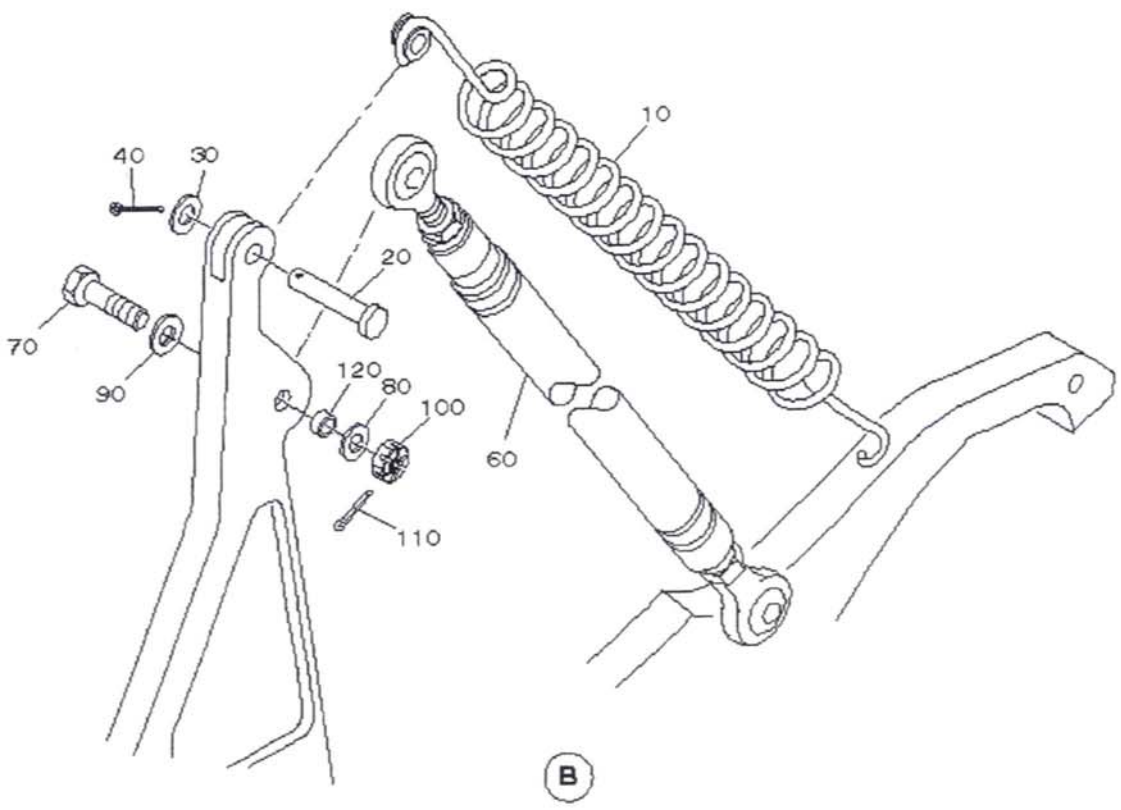
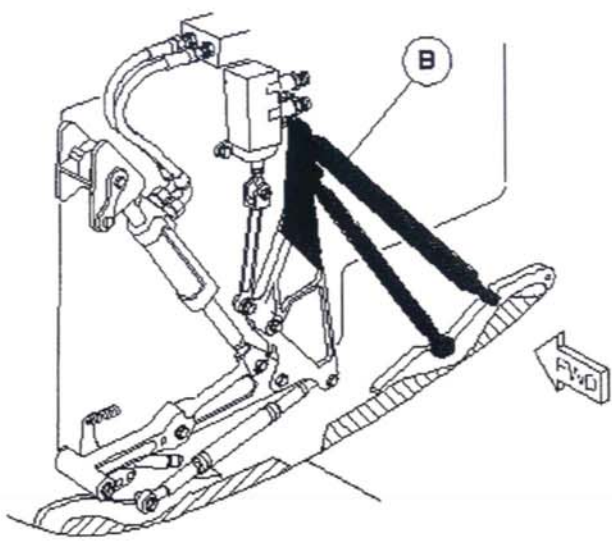
This EO is issued due to an incident in which the Nose Landing Gear failed to extend. Based on preliminary investigations results a one time inspection of the NLG forward door spring is required. Installation of serviceable spring is done iaw. EO-Q400-320067

**Classification:**

Inspection.

	Perf. STS/DK	Accomplishment instruction
<del>STS/DK</del> Q.I 5-6083	<del>5-0221</del>	1. Refer to AMM Task 32-00-00-840-801 and open and lock the nose and main landing gear doors.
<del>STS/DK</del> 5-0221		2. Remove spring p/n 47844-1 (ref. Fig. 1 item 10) from aircraft – put a tag on the spring stating A/C reg.
<del>STS/DK</del> 5-0221		3. Inspect spring retainers p/n 47845-1 for evidence of damage, and ensure that spring wire is tightly wound around retainer
<del>STS/DK</del> 5-0221		4. Visually inspect spring p/n 47844-1 for evidence of damage (nicks, dents, scratches, chafing) to the surface of the wire. Inspection must cover both outside and inside of surface spring.
<del>STS/DK</del> Q.I 5-7238		5. Liquid penetrant inspect critical areas and areas of damage per ASTM E-1417, TYPE 1, sensitivity level 3. Defects not to exceed MIL-STD-1907, grade "A" limits.
<del>STS/DK</del> Q.I 5-7238		6. Report all findings to CPHMRS/FRM- See mandatory report form. All Springs shall be delivered to CPHMRS/FRM along with a tag stating A/C reg. and findings

Aircraft S/N / Acreg...	Aircraft series Q400	Aircraft Effectivity ALL	Task Card Number
-------------------------	-------------------------	-----------------------------	------------------



**FIG. 1**

Aircraft S/N / Acreg..	Aircraft series	Aircraft Effectivity	Task Card Number
	Q400	ALL	

**\*\*\* MANDATORY REPORT FORM \*\*\***

**EO-Q400-320066**

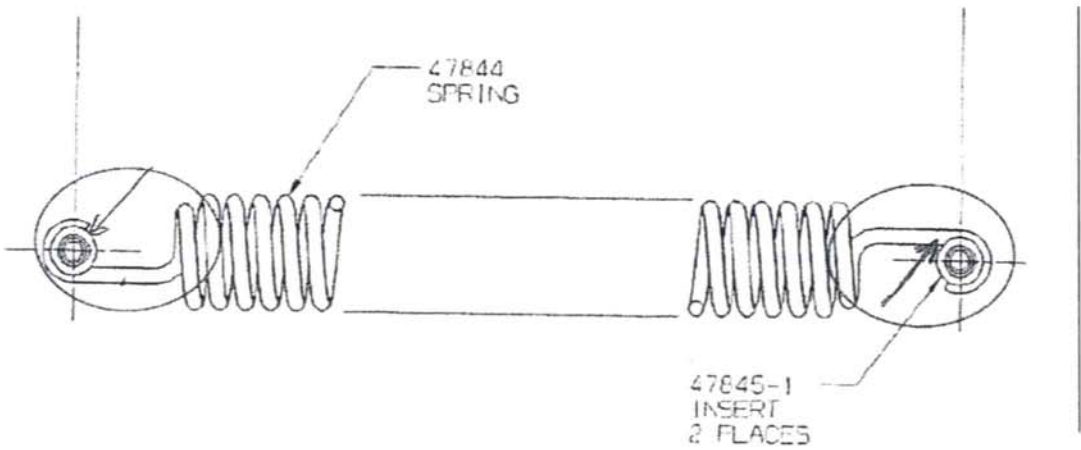
**NOTE:**  
MANDATORY REPORT FORM MUST ALWAYS BE FILLED IN BY THE PERFORMING SKILL.  
THE FORM MUST NOT BE SEPARATED FROM THE JOBCARD.  
JOBCARD (INCL. THE FORM) MUST BE DELIVERED TO THE RESPONSIBLE PLANNING AS SOON AS POSSIBLE.

**Reference:**  
RFQ ME-70239  
Bombardier AOM 249B  
Goodrich SCR 101-07B

**Subject:**  
Q400 – Removal and NDT Inspection of NLG forward door spring

Aircraft reg: LN-NDT Perf. date (DD/MM/YYYY): 25/9-02  
Perf. sign: Lee Colli Perf. Sta.: CPH

Report findings and illustrate:  
FOUND SHAFING ON RETAIN SPRING  
AROUND RETAINER  
NO Findings FPI






**THE LINES BELOW IS RESERVED FOR THE RESPONSIBLE PLANNING DEPT.:**

Copy of this report form must be forwarded to CPHMR-S / Frank Møller by e-mail; frank.moller2@sas.dk

COPIES FORWARDED BY DEPARTMENT: \_\_\_\_\_ SIGN: \_\_\_\_\_ DATE: 28 SEP. 2007  
STS/DK  
PP  
2-9024



SKILL:                      SKILL:                      SKILL:                      SKILL:                      SKILL:                      TO rev: **n**  
 ISSUED BY: **CPHTEU/LCE**    ISSUE DATE: **2007-10-01**                      PAGE: **1** OF **2**

A/C REG.  RDI		JOBCARD NO.  RDI	
ATTACH:                      ATTACH:		ATTACH:                      ATTACH:	
AMM 1:                      PAGEBLOCK:                      CODE:	AMM 5:                      PAGEBLOCK:                      CODE:	AMM 2:                      PAGEBLOCK:                      CODE:	AMM 6:                      PAGEBLOCK:                      CODE:
AMM 3:                      PAGEBLOCK:                      CODE:	AMM 7:                      PAGEBLOCK:                      CODE:	AMM 4:                      PAGEBLOCK:                      CODE:	AMM 8:                      PAGEBLOCK:                      CODE:
COMPNO:                      OUTSN:                      PN:	SNORG:	POS:	
COMPNO:                      INSN:                      PN:	SNORG:	VER: 3	
STATION: <b>STS</b> DATE: <b>12/07</b> SIGNATURE: 	<b>STS/DK</b> <b>DI</b> <b>2-1603</b>		

**\*\*\* AUTHORITY DEMAND \*\*\***

\*\*\*\*\*  
 ATTENTION RESPONSIBLE PLANNING: SEND MANDATORY REPORT BY E-MAIL  
 \*\*\*\*\*

- JOB ATTACHMENT: PDF EOQ320064.pdf
- JOB ATTACHMENT: PDF 32-31-11-400-801.pdf
- JOB ATTACHMENT: PDF 29-10-00-870-802.pdf
- JOB ATTACHMENT: PDF 32-31-00-870-801.pdf
- JOB ATTACHMENT: PDF 32-31-00-710-801.pdf
- JOB ATTACHMENT: PDF 32-34-00-710-801.pdf

*K C V*

ZONE: 721 Main gear

Subject:

Materials:

Qty	Part-No	Unit	Description
1	SE MATERIAL LIST ON ATTACHMENT	EACH	

Consumables:

Qty	Part-No	Unit	Description
1	See Consumable list on attachment	EACH	Consumable list

Tools:

Qty	No	Description
1	Q400 HYD. CART	HYDRAULIC GROUND CART

ZONE: 731 Main gear

Subject:

DI PERF.

**Materials:**

Qty	Part-No	Unit	Description
1	SE MATERIAL LIST ON ATTACHMENT	EACH	

**Consumables:**

1	See Consumable list on attachment	EACH	Consumable list
---	-----------------------------------	------	-----------------

**Tools:**

Qty	No	Description
1	Q400 HYD. CART	HYDRAULIC GROUND CART

ZONE: 711 Nose gear

Subject:

**Materials:**

Qty	Part-No	Unit	Description
1	SE MATERIAL LIST ON ATTACHMENT	EACH	

**Consumables:**

1	See Consumable list on attachment	EACH	Consumable list
---	-----------------------------------	------	-----------------

**Tools:**

Qty	No	Description
1	Q400 HYD. CART	HYDRAULIC GROUND CART



MAINTENANCE TASK CARD MANUAL

Aircraft S/N / Acreg..		Aircraft series Q400	Aircraft Effectivity ALL	Task Card Number EOQ320064
Issued by & Date CPHMR-U / LCE 01OCT07		Airline designator Code SK		JOBID FREO400-320064

\*\*\*\*\*  
**\*AUTHORITY DEMAND\***  
 \*\*\*\*\*

**Subject:**

Q400 – Installation of MLG Retraction Actuator p/n 46550-9 and Primary/Alternate Extension/Retraction Test of MLG and NLG

**Responsible Engineering:**

CPHMR-S / Frank Møller

**Reference:**

TCA-CF-2007-20/Q400  
Case no. MR-4295 and Q400-32-022  
RFQ ME-70317

**Reason:**

This EO is required in order to release aircraft to service after installation of MLG Retraction Actuator and Operational test of MLG & NLG Primary/Alternate Extension and Retraction System. Release to service will be approved by Geir Steiro /STOOM

**Classification:**

Minor Modification

**First Article Inspection (FAI):**

Yes

**Compliance:**

This EO complies with AD CF-2007-20/Q400 Paragraph C.  
This EO shall be performed when EO-Q400-320060 (if applicable), 61, 62 and 63 has been completed and signed off.

**Materials:**

#	P/N:	Subject:	Qty	Note
1.	46550-9	Retraction Actuator	1	Restored

**Consumables:**

#	P/N:	Subject:	Qty	Note
1.	04-03	Aeroshell Grease 7	A/R	USE RMC 691-016 -XX
2.	07-01A	Corrosion preventive compound F13 Grade2	A/R	USE RMC 693-060-01 (LPS3)
3.	RMC 842-004-02	Tape	A/R	

Aircraft S/N / Acreg..	Aircraft series Q400	Aircraft Effectivity ALL	Task Card Number EOQ320064
------------------------	-------------------------	-----------------------------	-------------------------------

DI STS/DK

**Accomplishment instruction for Main Landing Gear Left Hand Side:**

STS/DK  
DI  
2-1603  
  
STS/DK  
x-0014  
5-2641

1. Install MLG Lock Pins iaw. AMM 10-11-00-400-802
2. Install restored MLG Retraction Actuator p/n 46550-9 iaw. AMM 32-31-11-400-801.
3. Fill in mandatory report form.

1100-x  
K/SLS

**Accomplishment instruction for Main Landing Gear Right Hand Side:**

STS/DK  
DI  
2-1603  
  
STS/DK  
x-0011  
5-2641

4. Install MLG Lock Pins iaw. AMM 10-11-00-400-802
5. Install restored MLG Retraction Actuator p/n 46550-9 iaw. AMM 32-31-11-400-801.
6. Fill in mandatory report form.

STS/DK  
DI  
2-1603  
  
STS/DK  
5-2641

**Close out:**

7. Bleed the No. 2 hydraulic system iaw. AMM 29-10-00-870-802
8. Do an Operational Test of the Landing Gear Primary Extension and Retraction system iaw. AMM32-31-00-710-801
9. Pull the Co-pilot seat back and check if the Landing Gear Alternate Extension door in the floor adjacent to the co-pilot seat opens fully - with no interference between door and seat handle.
10. Do an Operational Test of the Alternate Extension System iaw. AMM 32-34-00-710-801
11. Do a visual check of the hydraulic components and connections for leaks
12. Remove all the tools, the equipment, and the unwanted materials from the work areas.

STS/DK  
K-0012

STS/DK  
x-0013

STS/DK  
x-0013  
  
STS/DK  
5-2641



Aircraft S/N / Acreg. <b>LN-RDI.</b>	Aircraft series <b>Q400</b>	Aircraft Effectivity <b>ALL</b>	Task Card Number <b>EOQ320064</b>
---	--------------------------------	------------------------------------	--------------------------------------

COPY

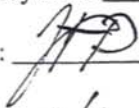
\*\*\*\*\*  
**MANDATORY REPORT FORM**  
\*\*\*\*\*

Send Mandatory Report FORM by e-mail to Frank Møller  
(frunk.moller2@sas.dk)

ACREG: LN-RDI.

Date: 10/10/07

MLG Retraction Actuator	Part No.	Serial no. in.
LH main gear	46550 - 9	MAL 0116.
RH Main gear	46550 - 9	MAL 0117.

Send by \_\_\_\_\_  
Employee nr: 5-2641  
Sign:   
Date: 11/10-07

<h2 style="margin: 0;">AUTHORIZED RELEASE CERTIFICATE</h2> <h3 style="margin: 0;">EASA FORM 1</h3> <h1 style="font-size: 2em; margin: 0; opacity: 0.5;">COPY</h1>		3. Form Tracking Number  5454561 /				
2. <b>WIDERØE'S FLYVESELSKAP AS</b> P.O. Box 247, Langstranda 6 N-8001 BODØ, NORWAY		5. Work Order / Contract / Invoice  CURO 6130				
6. Item	7. Description	8. Part No.	9. Eligibility*	10. Qty.	11. Serial / Batch No.	12. Status / Work
1	Retraction actuator assy mlg	46550-9	DHC8	1	MAL-0117	REPAIRED
13. Remarks  <p style="margin: 0;">Tsn: 10790:00 FH 11940 CY</p> <p style="margin: 0;">SCG Repair order no: 2HNO5714084. WF CURO 6130. Ref CMM 32-31-06 rev 05/05/2006 rev. 3. MODIFICATION: SCR086-07A, SCR091-07, MRM 320100-029 and SB 84-32-35 rev 06/jul 2004 performed. New piston, gland nut and rod-end installed.</p>						
14. Certifies that the items identified above were manufactured in conformity to: <input type="checkbox"/> Approved design data and are in condition for safe operation. <input type="checkbox"/> Non-approved design data specified in block 13						
15. Authorized Signature			19. <input checked="" type="checkbox"/> Part-145.A.50 Release to Service Certifies that unless otherwise specified in block 13, the work identified in block 12 and described in block 13, was accomplished in accordance with Part-145 and in respect to that work the items are considered ready for Release to Service.			
16. Approval / Authorization Number			20. Authorized Signature <div style="border: 1px solid black; padding: 2px; display: inline-block;">                     WIDERØE                      EASA NO. 145.0133                      Sign CRS 07/20.                 </div>			
17. Name			21. Certificate / Approval Ref. No.  <b>NO.145.0133</b>			
18. Date (d/m/y)			22. Name <i>JAN KASPERSEN.</i>			
18. Date (d/m/y)			23. Date (d/m/y) <i>09.10.2007.</i>			

### USER / INSTALLER RESPONSIBILITIES

- NOTE: 1. It is important to understand that the existence of the document alone does not automatically constitute authority to install the part/component/assembly.
2. Where the user / installer works in accordance with the national regulations of an Airworthiness Authority different from the Airworthiness Authority specified in block 2 it is essential that the user / installer ensures that his / her Airworthiness Authority accept parts / components / assemblies from the Airworthiness Authority specified in block 2.
3. Statements 14 and 19 do not constitute installation certification. In all cases the aircraft maintenance record must contain an installation certification issued in accordance with the national regulation by the user / installer before the aircraft may be flown.
- \* Installer must cross-check eligibility with applicable technical data.



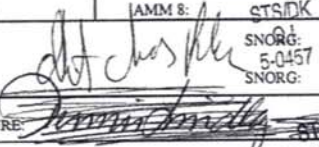
<h2 style="margin: 0;">AUTHORIZED RELEASE CERTIFICATE</h2> <h3 style="margin: 0;">EASA FORM 1</h3> <h1 style="font-size: 2em; opacity: 0.5; margin: 0;">COPY</h1>		3. Form Tracking Number 5454562 /	
1. Approving National Aviation Authority / Country <b>NCAA / NORWAY</b>		5. Work Order / Contract / Invoice CURO 6129	
4. Approved organization Name and Address: <b>WIDERØE'S FLYVESELSKAP AS</b> <b>P.O. Box 247, Langstranda 6</b> <b>N-8001 BODØ, NORWAY</b>			
6. Item	7. Description	8. Part No.	9. Eligibility*
1	Retraction actuator assy mig	46550-9	DHC8
		10. Qty.	11. Serial / Batch No.
		1	MAL-0116
		12. Status / Work REPAIRED	
13. Remarks  Tsn: 10790:00 FH 11940 CY  SCG Repair order no: 2HNO5714091, WF CURO 6129, Ref CMM 32-31-06 rev 05/05/2006 rev. 3. MODIFICATION: SCR086-07A, SCR091-07, MRM 320100-029 and SB 84-32-35 rev 06/jul 2004 performed. New piston, gland nut and rod-end installed.			
14. Certifies that the items identified above were manufactured in conformity to: <input type="checkbox"/> Approved design data and are in condition for safe operation. <input type="checkbox"/> Non-approved design data specified in block 13			
15. Authorized Signature		16. Approval / Authorization Number	
19. <input checked="" type="checkbox"/> Part-145.A.50 Release to Service Certifies that unless otherwise specified in block 13, the work identified in block 12 and described in block 13, was accomplished in accordance with Part-145 and in respect to that work the items are considered ready for Release to Service.		20. Authorized Signature EASA NO. 145.0133 Sign CRS # <i>107120</i>	
17. Name <i>JOHN KASPERSEN</i>		21. Certificate / Approval Ref. No. <b>NO.145.0133</b>	
18. Date (d/m/y)		22. Date (d/m/y) <i>09.10.2007.</i>	

### USER / INSTALLER RESPONSIBILITIES

- NOTE: 1. It is important to understand that the existence of the document alone does not automatically constitute authority to install the part/component/assembly.  
 2. Where the user / installer works in accordance with the national regulations of an Airworthiness Authority different from the Airworthiness Authority specified in block 2 it is essential that the user / installer ensures that his / her Airworthiness Authority accept parts / components / assemblies from the Airworthiness Authority specified in block 2.  
 3. Statements 14 and 19 do not constitute installation certification. In all cases the aircraft maintenance record must contain an installation certification issued in accordance with the national regulation by the user / installer before the aircraft may be flown.
- \* Installer must cross-check eligibility with applicable technical data.



WPID: \_\_\_\_\_ JOBSEQ: \_\_\_\_\_ CHTYP/PART: \_\_\_\_\_ ACREG/BOWID: **RDI298**  
 JOBCARDNAME: **INSP OF MLG AND RETRACTION ACTUATOR** **COPY** JOBID: **FREO400-320061**  
 ACTYP: **Q400** ACEFFCD: \_\_\_\_\_ ACSNORG: **4024** ZONE: **700** ZONE: \_\_\_\_\_ ZONE: \_\_\_\_\_ JOBCARD: **EOQ320061**  
 SKILL: \_\_\_\_\_ SKILL: \_\_\_\_\_ SKILL: \_\_\_\_\_ SKILL: \_\_\_\_\_ SKILL: \_\_\_\_\_ TO rev: **11**  
 ISSUED BY: **CPHMR/KP** ISSUE DATE: **2007-09-15** PAGE: **1 OF 1**

A/C REG. 		JOB CARD NO. 	
ATTACH: _____		ATTACH: _____	
AMM 1: PAGEBLOCK: CODE:	AMM 2: PAGEBLOCK: CODE:	AMM 3: PAGEBLOCK: CODE:	AMM 4: PAGEBLOCK: CODE:
AMM 5: PAGEBLOCK: CODE:	AMM 6: PAGEBLOCK: CODE:	AMM 7: PAGEBLOCK: CODE:	AMM 8: PAGEBLOCK: CODE:
COMPNO: OUTSN: PN:	COMPNO: INSN: PN:	SNORG: <b>5-0457</b> SNORG: _____ POS: _____ VER: 3	
STATION: <b>STS</b>	DATE: <b>20/9-07</b>	SIGNATURE: 	

**\*\*\* AIRWORTHINESS DIRECTIVE \*\*\***

- JOB ATTACHMENT: PDF EOQ320061.pdf
- JOB ATTACHMENT: AMM 05-47-04-210-802-000-002
- JOB ATTACHMENT: AMM 05-47-03-210-801-000-002
- JOB ATTACHMENT: AMM 32-31-11-000-801-000-002
- JOB ATTACHMENT: PDF RD8-4-32-059.pdf
- JOB ATTACHMENT: PDF SCR 086-07.pdf

**ZONE:** 700 Landing gear and landing gear doors

**Subject:**



MAINTENANCE TASK CARD MANUAL

Aircraft S/N / Acreg..		Aircraft series Q400	Aircraft Effectivity ALL	Task Card Number EOQ320061
Issued by & Date		Airline designator Code	AuRA Task Code EO-Q400-320061	JOBID
KP	14 Sep 2007			

\*\*\*\*\*  
 \* **AUTHORITY DEMAND** \*  
 \*\*\*\*\*

**Subject:** Q400 – Inspection of MLG and Retraction Actuator

**First Article Inspection (FAI):** Yes

**Reference:** EASA-2007-0252-E/Q400 with effective date 13 SEP 2007  
 TCA CF-2007-20/Q400 with effective date 12 SEP 2007  
 Bombardier R/D84-32-059, Rev 3 or later  
 Goodrich SCR 086-07 rev. NC. Rev B or later  
 Bombardier MRM part 1 Task Z700-03E & Z700-04E

**Classification:** Inspection.

**Reason:** AD notes (above) has been issued by Transport Canada (TCA) and from EASA. The requirement in the EASA-2007-0252-E/Q400 take precedence over TCA-CF-2007-20/Q400.  
 The AD's contains Return-to-Service Instructions and conditions and procedures for ferry flight to maintenance bases.

The background is the incidents with LN-RDK & LN-RDS in which the main landing gear collapsed following landing.

Ferry flight conditions and procedures are covered in EO-Q400-320060

**Responsible Engineering:** CPHMRS/Frank Møller

**Special Tooling:** Goodrich Tool Number p/n CG-56806

Send a No Charge Purchase Order to Goodrich for a tooling as detailed:

David Jacobsen: Email: [david.Jacobsen@goodrich.com](mailto:david.Jacobsen@goodrich.com)  
 Phone: 905-825-1515 x 3408  
 Fax: 905-825-1582

Note: Tools are already ordered.

**Spec. Reporting:** Report findings (see mandatory report form) immediately to CPHMR-S / Frank Møller Phone: +45-3232-2871 or Jørgen Skouborg Phone: +45-3232-4438. CPHMR to forward reports immediately to STOOM-H and STOME-S/48403

**Issuance of SoC:** No

Aircraft S/N / Acreg..	Aircraft series	Aircraft Effectivity	Task Card Number
RD <sup>i</sup>	Q400	ALL	

### Accomplishment instruction

DI

STS/DK  
5-1683A

5-1955

STS/DK

5-1955

#### Main Landing Gear RH side

1. Install the lock pins on the main landing gear (Refer to AMM Task 10-11-00-400-802)

2. **General Visual Inspection of the Main Landing Gear System:**

Perform a general visual inspection of the right hand main landing gear system in accordance with Bombardier DHC-8 Series 400 Maintenance Requirements Manual AMM 05-47-04-210-802 (right hand).

Rectify any discrepancy found prior to further flight.

STS/DK

5-0081

3. **General Visual Inspection of the Main Landing Gear Retract Actuator Jam Nut:**

- a. Remove actuator in acc. to AMM Task 32-31-11-000-801 (do not at this stage loosen jam nut and rod end).
- b. Perform a general visual inspection of the right hand main landing gear retract actuator jam nut to ensure the wire lock is in place and the nut is secured.

STS/DK

5-1955

4. **Detailed Visual Inspection of the Main Landing Gear Retract Actuator:**

- a. Fully compress Retract Actuator Piston. Using Tool number CG-56806, check retracted length of actuator. If tool cannot be inserted into eye bolt, remove lock wire and back off jam nut as required to disengage locking feature. Turn and record (in or out eye bolt turns) required to accept Tool number CG-56806.

STS/DK

5-1955

- b. Perform detailed visual inspection in accordance with Bombardier RD8/4-32-059 and Goodrich SCR 086-07, Rev B, page 2 and 3, step 5, 8, 9, 10 (except do not rework, and continue with remaining operation).

**NOTE:** If rod end (PN P342750) does not easily back out of piston without binding and with the use of a strap wrench, continue to **step 5**

STS/DK

5-1683A

5. **Reporting Requirement**

Make a label stating A/C reg , LH/RH MLG, P/N, S/N and manufacture date of Retraction Actuator.

Take digital photos (close-up) of eye bolt, piston and label, and send the picture together with Mandatory rep. form to CPHMRS/FRM by E-Mail to Employee no. 28601

STS/DK

5-1955

6. Removed Actuator to be placed in hangar service center



Aircraft S/N / Acreg. RDi	Aircraft series Q400	Aircraft Effectivity ALL	Task Card Number
------------------------------	-------------------------	-----------------------------	------------------

**Mandatory Report Form  
Right Hand MLG**

A/C Reg: LV ROE    Retract Actuator P/N 46550-7    S/N 0037    Mfg date from placard

Date:

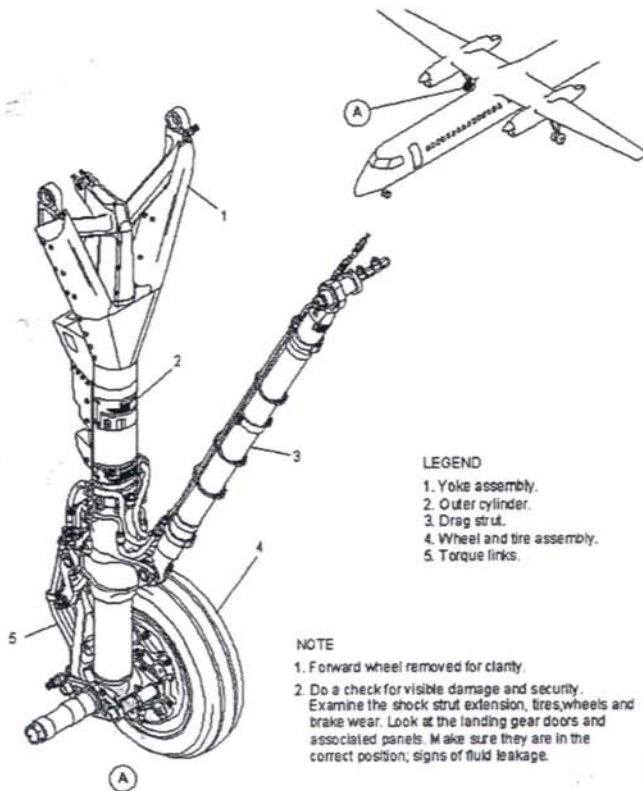
If any discrepancies is found please indicate on drawing and describe it below:

RH - A LITTLE OR NON PLAY BETWEEN PISTON AND BALL JOINT. JAM NOT NOT LOOSE, BALL JOINT STUCK IN PISTON.

NO FINDINGS ON RH MLG DURING GVI (P. 3 ITEM 2)

STS/DK

B-1055



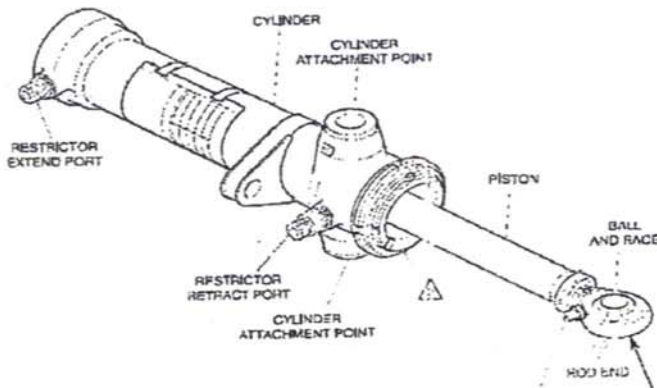
**LEGEND**

1. Yoke assembly.
2. Outer cylinder.
3. Drag strut.
4. Wheel and tire assembly.
5. Torque links.

**NOTE**

1. Forward wheel removed for clarity.
2. Do a check for visible damage and security. Examine the shock strut extension, tires, wheels and brake wear. Look at the landing gear doors and associated panels. Make sure they are in the correct position; signs of fluid leakage.

MAIN LANDING GEAR (RH)



Aircraft S/N / Acreg.. RDI	Aircraft series Q400	Aircraft Effectivity ALL	Task Card Number
-------------------------------	-------------------------	-----------------------------	------------------

**Mandatory Report Form  
Left Hand MLG**

A/C Reg: LN-RDI Retract Actuator P/N 46550-7 S/N 0057 Mfg date from placard

Date:

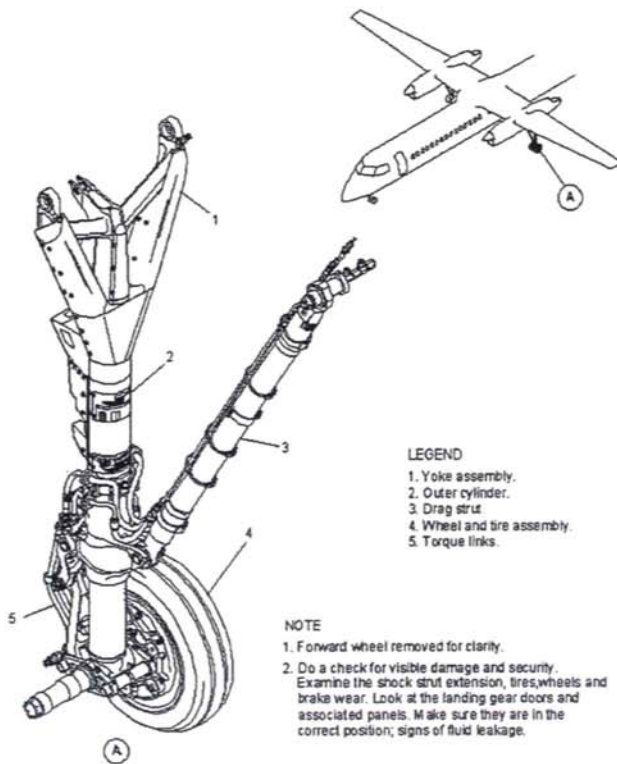
If any discrepancies is found please indicate on drawing and describe it below:

LH - EXTENSIVE PLAY BETWEEN PISTON AND BALL JOINT AND LOOSE JAM NUT.

NO FINDINGS LH MLG DURING GVI (P3 ITEM 2)

STS/DK

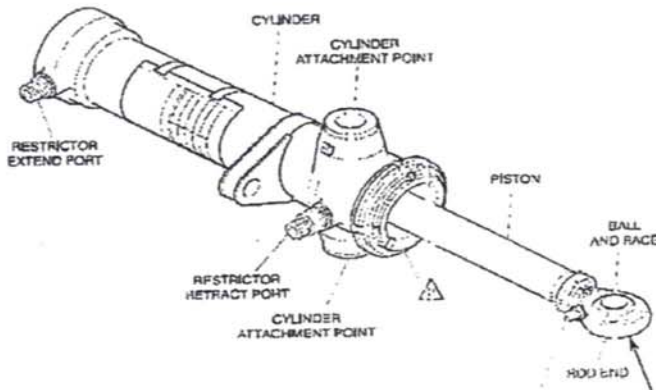
5-1955



- LEGEND
1. Yoke assembly.
  2. Outer cylinder.
  3. Drag strut.
  4. Wheel and tire assembly.
  5. Torque links.

- NOTE
1. Forward wheel removed for clarity.
  2. Do a check for visible damage and security. Examine the shock strut extension, tires, wheels and brake wear. Look at the landing gear doors and associated panels. Make sure they are in the correct position; signs of fluid leakage.

MAIN LANDING GEAR (LH)





# Deferred Items including MEL

## SELECTION CRITERIA

Aircraft Type:	\$ALL
Aircraft Number:	LN-RDI
Aircraft Base:	\$ALL
Deferral Type:	\$ALL
Deferral Status:	\$ALL
Log Page:	\$ALL
Due Date:	and

DEF AUTH ID	TYPE	MEL CODE	LOG PAGE	DEFERRAL DT	DUE DT	ST	WORK ORDER	EST LBR HRS	GROUND TM	OPER WORK PACKAGE	START DATE
<b>AIRCRAFT: LN-RDI</b>											
DEF00007441	DEF	2007-05-08 07:51, 24092		2007-02-28	2009-01-29	B	WO0297941	0.00	0		
<b>Remarks:</b> Correction: use RD 8/4-71-226 for tap test or ultrasonic inspection. Disregard RD8/4-71-207. CPHMR-S/PMT.											
----- Ref task Q400 560: L/H Cowl p/n 87144300-005 sn 0041. X-ray findings showing suspected moisture ingress. RD 8/4 71-226 allows temporary operation for 5000FC after which a permanent repair must be carried out. The cowl must be inspected using tap test or ultrasonic every A-check for details see RD8/4-71-207 section 1 sheet 1.											
DEF00007442	DEF	2007-02-28		2009-01-29	2009-01-29	B	WO0297950	0.00	0		
<b>Description:</b> L/H lower cowl moisture ingress											
DEF00007543	DEF	2007-03-02		2008-02-25	2008-02-25	B	WO0301028	46.00	21		
<b>Remarks:</b> Ref task Q400 560: R/H Cowl p/n 87144300-007 sn 0042. X-ray findings showing suspected moisture ingress. RD 8/4 71-225 allows temporary operation for 5000FC after which a permanent repair must be carried out. The cowl must be inspected using tap test or ultrasonic every A-check for details see RD8/4-71-225 section 1 sheet 1.											
<b>Description:</b> R/H Lower Cowl moisture ingress											
DEF00012636	DEF	Z100		2007-07-27	2008-02-27	B	WO0515747	3.00	4		
<b>Remarks:</b> RH Engine sn PCE-FA0088: During borescope found small exit duct damaged, pictures evaluated by engineering and PWC. Engine is ok for continued operation, borescope inspection to be carried out for every 150FH ( JAW AMM 72-00-00-290-035 )											
DEF00013068	DEF	LOAN FROM WDEROE / PN 399300-1009 SN 171 -		2007-08-10	2008-01-23	B	WO0526496	0.00	0		
<b>Description:</b> 842710 MTRL ORD DOT 31JUL JIMMY MT-P RDI5747											
DEF00013077	DEF	Retorque Fuel tank access panels 521AT, 521BT and 621BT ref. Amm 57-11-06-400-802		2007-11-08	2007-11-08	B	WO0527686	4.00	5		
<b>Description:</b> Retorque Fuel tank access panel 521AT, 521BT and 621BT											
DEF00014149	DEF	law amm task 27-61-01-830-803 check tension on all spoiler cables LH & RH wing for correct tension after installation of spoiler cables. first check after 7 day, and repetiv-chk. once a week, until there is no change in cable tension for the subsequent three weeks.		2007-09-05	2008-02-03	B	WO0550876	4.00	4		
<b>Description:</b> Check spoiler cable tension LH & RH Wing											
DEF00014167	DEF	Z001		2007-09-06	2008-02-21	B	WO0551243	24.00	24		
<b>Remarks:</b> LH CENTER FUEL TANK PANELS NEEDS RETORQED WITHIN 1000 FLIGHT HOURS.											
DEF00014739	DEF	2007-09-20		2007-12-13	2007-12-13	B	WO0563961	4.00	8		
<b>Remarks:</b> TRANS PUMP INSTALLATION: DURING INSTALLATION OF LH TRANSF PUMP CANISTER, FOUND ONE GUID PIN MISSING. ALT PIN TEMP INSTALLED. ALSO FOUND CLAMP RING DAMAGED. RING TEMP REPAIRED. ACTION WANTED: REPLACE BOTH GUID PINS, BOTH ANTI-FRET RINGS AND CLAMP RING IAW IPC 28-21-31 AND DWG 85C0743.											
<b>Description:</b> 3 ea. bond areas on r/h prop blad # 3 repaired law eqo610004. replace blade pos 3 within 500 fh. repeat insp. with 100 fh.											
DEF00014745	DEF	2007-09-20		2007-12-13	2007-12-13	B	WO0564119	7.00	9		
<b>Description:</b> MTRL ORD DOT RDI3961 / 21SEP07 PALLE MT-P											
DEF00014746	DEF	2007-09-20		2007-12-13	2007-12-13	B	WO0564120	7.00	9		
<b>Remarks:</b> Repetitive inspection...											
<b>Description:</b> P/N 697071003 needed											
<b>Description:</b> MTRL ORD DOT RDI4119 / 21SEP07 PALLE MT-P											
<b>Remarks:</b> Repetitive inspection.											
<b>Description:</b> P/N 697071003 needed											
<b>Description:</b> MTRL ORD DOT RDI4120 / 21SEP07 PALLE MT-P											

**DEF AUTH ID    TYPE    MEL CODE    LOG PAGE    DEFERRAL DT    DUE DT    ST    WORK ORDER    EST LBR HRS    GROUND TM    OPER WORK PACKAGE    START DATE**  
**DISCREPANCY**

DEF AUTH ID	TYPE	MEL CODE	LOG PAGE	DEFERRAL DT	DUE DT	ST	WORK ORDER	EST LBR HRS	GROUND TM	OPER WORK PACKAGE	START DATE
<b>AIRCRAFT: LN-RDI</b>											
DEF00015418	DEF			2007-10-08	2007-12-31	B	WO0578533	1.00	1		
<b>Remarks:</b> Ref WO 0577921.Loose actuator jam nuts.											
<b>Description:</b> Repeat inspection with 50 FH interval until Final action.											
DEF00015420	DEF			2007-10-08	2007-12-31	B	WO0578548	1.00	1		
<b>Remarks:</b> Ref WO 0577940.Loose actuator jam nuts.											
<b>Description:</b> Repeat inspection with 50 FH interval until Final action.											
DEF00015421	DEF			2007-10-08	2007-12-31	B	WO0578550	1.00	1		
<b>Remarks:</b> Ref WO 0577940.Loose actuator jam nuts.											
<b>Description:</b> Repeat inspection with 50 FH interval until Final action.											
DEF00015626	DEF			2007-10-12	2007-10-15	B	WO0583475	0.00	0		
<b>Remarks:</b> Info: During removal of spoiler panel cutting of the main hinge bolt was required. NAS77-5-25 bushing sustained some scratches during the process.											
Temporary action: Polish flange at damaged areas. Leave the two undamaged areas as-is. Install bushing.											
Final action (after max. 25 fl. cycles): Replace bushing with new NAS77-5-25. CPHMR-S/PMT.											
<b>Description:</b> Perform Final action after max. 25 fl.cycl.											

**TOTAL AIRCRAFT REPORTED: 1**

**TOTAL DEFERRALS REPORTED: 15**

**\*\* END OF REPORT \*\***





**Airworthiness Directives  
Compliance Status  
Landing Gear Related AD**

**LN-RDI**

Model: Q400  
TT A/C: 12032 H  
TC A/C: 14923 C

Mfg Date: 23SEP2000

MSN: 4024

AD-Number Effective Date	Para & Sub	Subject / Compliance	Method of Compliance		Accompl. Status		Additional Information
			External Ref	Action Ref	Complied	Next Due	
EASA-2007-0252-E/Q400 14SEP2007		Subject: Landing Gear - Main Landing Gear System & Parts - Inspection					<b>AIRFRAME</b>  AD Supersedes: TCA-CF-2007-20/Q400  <b>Remarks:</b> EO-Q400-320061 covers the removal, inspection and reporting of actuators. Removed actuators sent for repair or are being discarded. EO-Q400-320064 installs new actuators.  <b>Remarks:</b> This paragraph applies to aircraft with less than 8000 FH - and is therefore not applicable to SAS Q400 a/c individuals.  <b>Applicability:</b> Only applicable for ferry flights.  <b>Remarks:</b> Finding reporting included in EO-Q400-320061.  <b>Related AD:</b> SLV-2002-235-128 FAA-2004-14-15 <b>AD Supersedes:</b> TCA-CF-2001-16  <b>Remarks:</b> ModSum 4& 8209;113331. OY-KCG (4063) Mod. incorporated at delivery.  <b>Remarks:</b> The AFM amendment was added to the AFM and Crew informed law MTO 321240 with a deadline 18MAY2001. /III/ AFM Amendment to be removed law EO-Q400-320027 (MTO321246B)
	(a)	Subject: Perform tasks described in § A, B and C.1 of AD TCA-CF-2007-20. <b>Compliance:</b> Before further flight		EO-Q400-320061 EO-Q400-320061R01 EO-Q400-320064 EO-Q400-320064R01	20SEP2007 N/A N/A 12OCT2007		
	(b)	Subject: Perform tasks described in § C.2 of AD TCA-CF-2007-20. <b>Compliance:</b> Within 500H after 13SEP2007.					
	(c)	Subject: If required, Issue Ferry flight permits in accordance with AD TCA-CF-2007-20 § E, however item 4, 5 and 6 in accordance with Q400 AFM (doc PSM 1-84-1A), and <b>Compliance:</b> Before ferry flight		EO-Q400-320060R01	16SEP2007		
TCA-CF-2001-16:R1 11JUL2002		Subject: Main LDG procedure <b>Compliance:</b> Se AD paragraphs					
	A	Subject: Replace the L/H and R/H main landing gear down lock proximity sensors with improved version by incorporating retrofit <b>Compliance:</b> Prior to 31 December 2002.	BOMBARDIER-SB84-32-09 BOMBARDIER-SB84-32-09	EO-COMP-320001 EO-Q400-320009	N/A 25JUL2001		
	B	Subject: With either production Modsum 4& 8209;113330 or retrofit Modsum 4- 113331 incorporated, the procedures previously added by Airworthiness Directive CF-2001-	BOMBARDIER-SB84-32-09	EO-Q400-320027	09AUG2002		



**Airworthiness Directives  
Compliance Status  
Landing Gear Related AD**

**LN-RDI**

Model: Q400  
TT A/C: 12032 H Mfg Date: 23SEP2000  
TC A/C: 14923 C MSN: 4024

AD-Number Effective Date	Para & Sub	Subject / Compliance	Method of Compliance		Accompl. Status		Additional Information
			External Ref	Action Ref	Complied	Next Due	
TCA-CF-2002-13:R2 04FEB2002		16, to Section 4.21 of the Aircraft Flight Manual, PSM 1 & 8209;84 & 8209;1A (Models 400, 401, & 402), are no longer required and are to be removed <b>Compliance:</b> Prior to 31 December 2002.					when Fleet has been modified iaw EO-Q400-320009.
	C	<b>Subject:</b> Inform all flight crews of this change to the AFM <b>Compliance:</b> Prior to 31 December 2002.	BOMBARDIER-SB84-32-09	EO-Q400-320027	09AUG2002		
	D	<b>Subject:</b> Accomplishment of paragraphs A, B, and C is considered terminating action to this directive <b>Compliance:</b> Ref Part A, B and C					
	Info	<b>Subject:</b> MLG uplock assembly <b>Compliance:</b> PART I: MTO-321287 EFFDATE 2005-06-17 PART II:MTO-321288 EFFDATE 2005-06-17 NOTE: R2 provides alt insp requirement for 46500-5, ilo lifelimit as per R1 Introduction PN 46500-7 is considered TERMINATING ACTION					<b>Action Note:</b> AuRA configuration is updated to prevent the installation of P/N 46500-5 and lower dash-numbers. AuRA configuration verified 28MAR 2007 <b>Related AD:</b> SLV-2005-226 <b>AD Supersedes:</b> TCA-CF-2002-13:R1
	Part I A	<b>Subject:</b> Amend AFM 1-84-1A section 4-21-1 Advice crew <b>Compliance:</b> Within three calendar days after 4 February 2002 (the effective date of the original issue of this directive), amend all copies of the Aircraft Flight Manual (AFM), PSM 1-84-1A (Models 400, 401, 402) by adding the following procedure opposite to page 4-21-1. Advise all flight crews of these changes. Note: The amendment required may be accomplished by inserting a copy of this directive into the affected section of the Airplane Flight Manual.	BOMBARDIER-SB84-32-29 BOMBARDIER-SB84-32-29	EO-COMP-320003 EO-COMP-320003R02 EO-Q400-320017	N/A N/A 06FEB2002		<b>Applicability:</b> MSN 4001 and subsequent. <b>Remarks:</b> The Part 1A was formally introduced into the AFM by MTO 321287 (later EO-Q400-320017)  Flw immediate action was taken before the formal TO(EO): CPHYO-B to take corrective actions according Transport Canada AD CF-2002-13 as follows. a). Add procedure (AD) opposite to page 4-21-1 of the Aircraft Flight Manual, PSM 1-84-1A (Models 400,401,402) b) Inform all flight crews of this change to the AFM. c) CPHYO-B to inform CPHYE when corrective actions has been fulfilled.
	Part I B	<b>Subject:</b> Upon replacing both left and right					<b>Remarks:</b> AFM instruction removed and verified





**Airworthiness Directives  
Compliance Status  
Landing Gear Related AD**

**LN-RDI**

Model: Q400  
TT A/C: 12032 H  
TC A/C: 14923 C  
Mfg Date: 23SEP2000  
MSN: 4024

AD-Number Effective Date	Para & Sub	Subject / Compliance	Method of Compliance		Accompl. Status		Additional Information
			External Ref	Action Ref	Completed	Next Due	
		main landing gear up-lock assemblies with P/N 46500-7 up-lock assemblies, remove the procedures mandated in Part I, paragraph A above from the AFM. Advise all flight crews of this change. Compliance: Ref. "Subject"					done on 21MAR 2007 (13:16 LT) via RAIS and RM Notam. papers revised at first occasion
Part II A.1		<b>Subject:</b> Replace Uplock unit <b>Compliance:</b> Before accumulating 2500H or 3000C whichever comes first. For uplock unit above those limitation, within 14 days from effective date.	BOMBARDIER-SB84-32-15	EO-Q400-320018	01MAR2002		<b>Applicability:</b> MSN 4001 and subsequent with Uolock Assembly P/N 46500-3 and 46500-5.
Part II A.2		<b>Subject:</b> Replace Uplock unit <b>Compliance:</b> At 2500H/3000C interval	BOMBARDIER-SB84-32-15	EO-Q400-320018	01MAR2002		<b>Applicability:</b> MSN 4001 and subsequent with Uolock Assembly P/N 46500-3 and 46500-5. <b>Remarks:</b> KN 843224 demand; CBB: 3000 & HBB: 2500 PN 46500-3 shall be replaced.
Part II B.1		<b>Subject:</b> Insp Uplock Roller iaw A84-32-15 <b>Compliance:</b> Within 30 days from effective date.	BOMBARDIER-SB84-32-15	EO-Q400-320018	01MAR2002		<b>Applicability:</b> MSN 4001 and subsequent.
Part II B.2		<b>Subject:</b> Replace Uplock Roller not having inner friction liner with P/N 46575-1 <b>Compliance:</b> Within 30 days from effective date.	BOMBARDIER-SB84-32-15	EO-Q400-320018	01MAR2002		<b>Applicability:</b> MSN 4001 and subsequent.
Part II C		<b>Subject:</b> Part II C Inspection of P/N 46500-5 Up-lock Assemblies:					
Part II C.1		<b>Subject:</b> Inspection of P/N 46500-5 Up-lock Assemblies: Inspect the surface of the up-lock latch lower jaw for the presence of a wear groove and measure the wear groove depth to a 0.001 inch accuracy in accordance with DHC-8 Series 400 AMM, PSM 1-84-2, Task 32-31-21-220-801. If the groove depth exceeds 0.007 inches, replace the up-lock assembly with a new or overhauled P/N 46500-7 up-lock assembly as per instructions given in Chapter 32-31-21 of the AMM PSM 1-84-2.	BOMBARDIER-SB84-32-15	EO-Q400-320018	01MAR2002		<b>Applicability:</b> 1st inspection iaw KTO 321288 (later EO-Q400-320018), then iaw KN 843224 demand / P601 <b>Remarks:</b> P601 entry. P/N 46500-7 has no replacement limit or repetitive Inspection Requirement - AD-CF-2002-13R2



**Airworthiness Directives  
Compliance Status  
Landing Gear Related AD**

**LN-RDI**

Model: Q400  
TT A/C: 12032 H Mfg Date: 23SEP2000  
TC A/C: 14923 C MSN: 4024

AD-Number Effective Date	Para & Sub	Subject / Compliance	Method of Compliance		Accompl. Status		Additional Information
			External Ref	Action Ref	Complied	Next Due	
	Part II C.2	<p><b>Compliance:</b> Prior to the up-lock assembly accumulating 2500 hours air time or 3000 flight cycles, whichever occurs first; and thereafter, at intervals not exceeding 400 hours air time or 480 flight cycles, whichever occurs first.</p> <p><b>Subject:</b> Inspect the up-lock roller, P/N 46575-1, to ensure that it rotates freely. If the uplock roller does not rotate freely, replace the up-lock roller with a roller of the same part number, as per instructions given in Chapter 32-31-21 of the AMM PSM 1-84-2.</p> <p><b>Compliance:</b> Prior to the up-lock assembly accumulating 2500 hours air time or 3000 flight cycles, whichever occurs first; and thereafter, at intervals not exceeding 400 hours air time or 480 flight cycles, whichever occurs first.</p>	BOMBARDIER-SB884-32-15	EO-Q400-320018	01MAR2002		<p><b>Applicability:</b> 1st inspection law KTO 321288 (later EO-Q400-320018), then law KN 843224 demand / P601</p> <p><b>Remarks:</b> P601 entry: P/N 46500-7 has no replacement limit or repetitive Inspection Requirement - AD-CF-2002-13R2</p>
	Part III	<p><b>Subject:</b> Terminating Action. Replacement of both left and right up-lock assemblies with P/N 46500-7 up-lock assemblies terminates the Part I Air Operator Action and Part II Maintenance Action of this directive. <b>Compliance:</b> No deadline</p>	BOMBARDIER-SB884-32-29 BOMBARDIER-SB884-32-29	EO-COMP-320003 EO-COMP-320003R02	N/A N/A		<p><b>Applicability:</b> All A/C</p> <p><b>Remarks:</b> TO 321387 marked with a date (completed) or N/A indicates that a P/N 46500-7 is installed.</p>
<b>ARQ</b>							
TCA-CF-2004-19 20OCT2004		<p><b>Subject:</b> ALI-37; Incomp. Rev. Structural Inspection Tasks. ALI-28; Incomp. Rev Safe Lifelimits for Orifice Support Tube, Upper Bearing, Piston Plug <b>Compliance:</b> 2004-10-20 NOTE: KN affected 844259, 844260, 844261</p>					<p><b>Related AD:</b> SLV-2004-357, FAA-2005-12-15</p>
1.		<p><b>Subject:</b> Incorporating the revised structural inspection tasks, 712001F102 and</p>		EO-Q400-710015	26OCT2004		<p><b>Applicability:</b> DHC-8 Aircraft, Models 400, 401 and 402, serial numbers 4001, and 4003 through</p>



**Airworthiness Directives  
Compliance Status  
Landing Gear Related AD**

**LN-RDI**

Model: Q400  
TT A/C: 12032 H  
TC A/C: 14923 C

Mfg Date: 23SEP2000

MSN: 4024

AD-Number Effective Date	Para & Sub	Subject / Compliance	Method of Compliance		Accompl. Status		Additional Information
			External Ref	Action Ref	Complied	Next Due	
		712003F102 respectively as introduced by Temporary Revision, ALI-37 of Airworthiness Limitations Items (ALI) of the DHC-8-400 Maintenance Requirements Manual, PSM 1-84-7 <b>Compliance:</b> Within 30 days after the effective date of this directive					4094. Remarks: EO-Q400-710015 (KTO-710422) to describe and ensure compliance
	2.	<b>Subject:</b> Incorporating the revised safe life limits for the Orifice Support Tube, P/N 46117-1, Upper Bearing, P/N 46114-1, and Piston Plug, P/N 46137-1, as introduced by Temporary Revision, ALI -28 of Airworthiness Limitations Items (ALI) of the DHC-8-400 Maintenance Requirements Manual, PSM 1-84-7. <b>Compliance:</b> Within 30 days after the effective date of this directive		EO-Q400-710015	26OCT2004		<b>Applicability:</b> DHC-8 Aircraft, Models 400, 401 and 402, serial numbers 4001, and 4003 through 4094. <b>Remarks:</b> EO-Q400-710015 (KTO-710422) to describe and ensure compliance. P/N 46117-1 (MOPS P601 "CBL set to 13311" 06OCT2004) P/N 46114-1 (MOPS P601 "CBL set to 22032" 06OCT2004) P/N 46137-1 (MOPS P601 "CBL set to 22032" 06OCT2004) Demanded interval 14500 C (P/N 46117-1) and 24000 C (P/N 46114-1 and 46137-1) multiplied with HGW factor 0.918 due to ModSum 4-308807. Referred "ALI-28" has been replaced by later "ALI"s.
<b>XX-Q400</b>		<b>Subject:</b> This record is created to enable presentation of status on the NLD Door Springs (EO-Q400-320066 and EO-Q400-320067) and, The rework of NLG door debris guard panel for each aircraft through the AD Manager printout function.		EO-Q400-320066 EO-Q400-320067 EO-Q400-320072	26SEP2007 12OCT2007 07OCT2007		<b>Action Note:</b> EO-Q400-320066 covers the removal and NDT-inspection of the NLG FWD door spring EO-Q400-320067 covers the re-installation of the NLG FWD door spring and EO-Q400-320072 covers the rework of NLG door debris guard panel

Created 12OCT2007

Last page of list



## **Bilag 39**



## Bombardier Q400

### All Operator Message No. 263

---

ATTN: Director/Manager of: Maintenance  
Engineering  
Quality Control  
Flight Operations  
Procurement/Spares

DATE: 03 Nov 2007

ATA: 2900, 3230 MODEL: Q400

SUBJECT: Update from the Danish Investigation Board

REFERENCE: Please refer to release on page 3 and 4

The following message is being sent to all Bombardier Aerospace Regional Aircraft Q400 Operators and Bombardier Aerospace Regional Aircraft Field Service Representatives.

This message contains information requiring attention and/or action. Please ensure timely and appropriate distribution within maintenance and flight operations departments.

---

#### DISCUSSION:

As a result of the information contained in the preliminary report, attached below, Operators are advised that should a Solenoid Sequence Valve (SSV) or Mechanical Sequence Valve (MSV) be replaced, care should be taken to ensure that FOD is not collected and transferred during the replacement of serviceable unit/s.

Although highly improbable that the transfer of such FOD would have a major impact on the hydraulic system, under special circumstances the migration of such FOD could cause the landing gear system to malfunction.

Operators are encouraged to ensure that only official documentation is used when changing components, that unions and fixtures on the SSV and MSV are not swapped out with alternative components without thorough care and cleaning, and only if following approved, documented procedures.

Under normal circumstances FOD will be captured by the existing filters and valves but unapproved procedures without care can bypass these safeguards.

Bombardier recommends that any operator that has replaced any of these components in the last 500 flight cycles flush the hydraulic lines within 50 hours as follows: (See RIL 84-29-035)

- Jack the aircraft in accordance with task 07-10-00-582-801
- Lock Main Landing Gear per task 10-11-00-400-802, the Nose Gear per 10-11-00-400-801 and ensure the Landing Gear Doors are locked in accordance with 32-00-00-840-801
- Follow the hydraulic system precautions per task 29-00-910-801.
- On the ground service panel, connect the GHPU to the No.2 Hydraulic System quick disconnects ports per task 12-00-16-490-801.
- Remove the following LRUs:
  - MLG Doors Mechanical Sequence Valve per 32-31-36-000-801
  - Solenoid Sequence Valve per 32-31-41-000-801
  - Restrictors Inline-MLG Doors per 32-31-38-000-801 (Qty. 2)
- Install suitable flex hoses at the removed LRU locations. Ensure no crossover between the lines.
- Disconnect the retraction actuator flex lines and route to a waste container. Install extension hoses if necessary.
- Run the GHPU at a flow 7-10 gpm at 1800 psi and flush the lines for 5 minutes.
- Shut down GHPU.
- Select Gear Up and allow for flushing again in the reverse direction with the GHPU flow rate of 7-10 gpm at 1800 psi for 5 minutes.
- Shut down GHPU.
- Visually inspect LRUs prior to installation. Install the removed LRUs as noted above:
  - MLG inline restrictors per 32-31-38-400-801 (Qty. 2)
  - Solenoid Sequence Valve per 32-31-41-400-801
  - MLG Doors Mechanical Sequence Valve per 32-31-36-400-801
- Shut down GHPU.
- Bleed the No. 2 Hydraulic System per task 29-10-00-870-802.
- Perform pressure check of the No. 2 Hydraulic System in accordance with 29-00-00-863-801. Ensure there are no leakages.
- Perform 25 gear swings in accordance with 32-31-00-710-801.
- Perform a minimum of 5 Alternate Extension System tests.
- Check reservoir quantity per 12-10-29-210-801.
- Service as necessary and close-out activities.

Please direct responses and inquiries to your Bombardier Aerospace Regional Aircraft Field Service Representative or the Technical Help Desk in Toronto at telephone (416) 375-4000 or facsimile (416) 375-4539 or e-mail: [thd.qseries@aero.bombardier.com](mailto:thd.qseries@aero.bombardier.com)

Michel Babin, Manager, In-Service Engineering Systems, and Martin Elliot, Director, In-Service Engineering & Technical Support, Bombardier Aerospace Regional Aircraft.

**PRELIMINARY REPORT 03-11-2007**

<b>HCLJ510-000449</b>		<b>ACCIDENT</b>	
Type of aircraft:	Dash 8-Q400	Registration:	LN-RDI
Engines:	2 PW150A	Type of flight:	Scheduled passenger, IFR
Crew:	4 – No injuries	Passengers:	40 - No injuries
Place of occurrence::	Copenhagen Airport	Date and time:	27.10.2007 at 1453 UTC

**Investigation update**

During the examination of the retraction/extension actuator assembly from the right main landing gear of the occurrence aircraft, an O-Ring was found blocking the orifice in the restrictor valve.

The blocked orifice within the actuator assembly prevented the normal extension of the right main landing gear.

The physical dimensions of the rogue O-Ring was similar to that of the NAS1611-110 O-Ring identified on the drawings for the door solenoid sequence valve (SSV). It was further determined that the only component in the landing gear system that incorporated this O-Ring was the SSV.

A review of the maintenance history identified that an SSV on the right main landing gear system had been replaced on 16 October 2007. This component was located and examined. The examination revealed that a filter element and an O-Ring were not present in the down port in the SSV. To establish similarity with the rogue O-Ring, an O-Ring was removed from a second SSV and was examined. They were found to be identical in both size and in material composition.

In the course of this investigation, the Danish AIB became aware that past occurrences showed that filter elements in the SSV can collapse and migrate into the landing gear hydraulic system. In the past occurrences, O-Rings (situated adjacent to the filter) from the SSV's are not known to have migrated into the landing gear hydraulic system.

However it is the conclusion of the Danish AIB, that the O-ring found blocking the right main landing gear actuator restrictor valve, was from the SSV that was previously installed on the occurrence aircraft.

A review of the aircraft's hydraulic system concluded that the rogue O-Ring could not have traveled from the SSV to its final location in the right main landing gear retraction/extension actuator restrictor valve. This conclusion is supported by a detailed analysis of the other valves and fittings in the system between these two components. The analysis showed that while some of the hydraulic tubes will allow free passage of a rogue O-Ring, other of the valve components, such as the mechanical sequence valve (MSV) are of such a design that the O-Ring could not have passed through them.

A further review of the maintenance history revealed that the MSV of the right main landing gear was replaced on 22 October 2007.

According to the maintenance records, the replacement MSV, supplied, was a P/N 48303-7 which was initially configured for installation into the nose landing gear hydraulic system. Prior to installation on the occurrence aircraft, the supplied MSV was reconfigured by maintenance personnel. To make the MSV P/N 48303-7 compatible with the installation requirements for the main landing gear, the unions from the replaced MSV P/N 48303-5 were used.

During the replacement of the MSV, the rogue O-Ring found blocking the orifice in the restrictor valve of the accident aircraft could, hidden in a union, have unknowingly been transferred from one side of the MSV to the other side by maintenance personnel.

Following a possible transfer of the O-Ring, it could travel through the hydraulic lines towards the main landing gear retraction/extension actuator restrictor valve causing the blockage of the valve.

The investigation continues.